

# HAMEG

Instruments

## MANUAL

Oscilloscope  
HM305-2

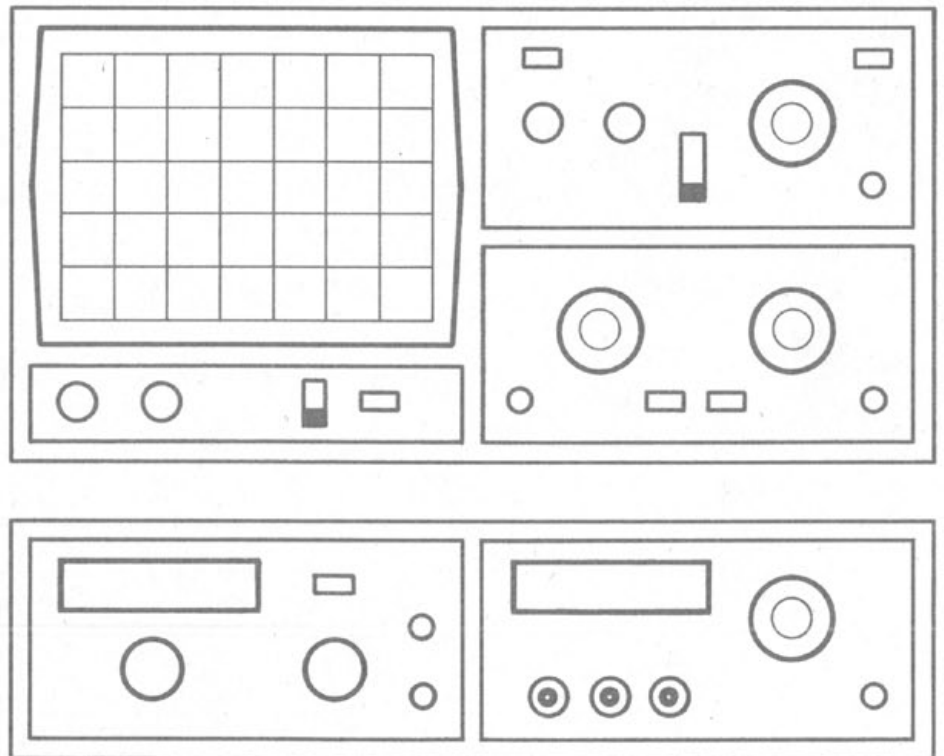

General information regarding the CE marking .....	2	Test Procedure .....	33
<b>Data sheet HM305-2</b> .....	3	Test Pattern Displays .....	33
Accessories .....	4	Testing Resistors .....	33
<b>General Information</b> .....	5	Testing Capacitors and inductors .....	33
<b>Symbols</b> .....	5	Testing Semiconductors .....	33
Use of tilt handle .....	5	Testing Diodes .....	33
Safety .....	5	Testing Transistors .....	34
Intended purpose and operating conditions .....	5	In-Circuit Tests .....	34
<b>SAFETY</b> .....	5	<b>STORAGE MODE</b> .....	35
EMC .....	6	Signal recording modes .....	35
Warranty .....	6	Vertical resolution .....	35
Maintenance .....	6	Horizontal resolution .....	36
Protective Switch-Off .....	6	Maximum signal frequency in storage mode .....	36
Power supply .....	6	Alias signal display .....	36
<b>Type of signal voltage</b> .....	7	Operating modes of the vertical amplifiers .....	36
Amplitude Measurements .....	7		
Voltage values of a sine curve .....	7		
Total value of input voltage .....	8		
Time Measurements .....	8		
<b>Connection of Test Signal</b> .....	10		
<b>Controls and Readout</b> .....	11		
Analog mode .....	12		
Pretriggering .....	14		
Post-triggering .....	14		
Voltage measurement in DUAL .....	15		
Voltage measurement with ADD .....	16		
Voltage measurement in XY .....	16		
Time /frequency measurement .....	16		
<b>Menu</b> .....	22		
<b>First Time Operation</b> .....	23		
Trace Rotation TR .....	23		
Probe compensation and use .....	23		
Adjustment at 1kHz .....	23		
Adjustment at 1MHz .....	24		
<b>Operating modes of the vertical amplifiers in Yt mode</b> ...	24		
X-Y Operation .....	25		
Phase comparison with Lissajous figures .....	25		
Phase difference measurement in DUAL mode (Yt) .....	26		
Phase difference measurement in DUAL mode: .....	26		
Measurement of an amplitude modulation: .....	26		
<b>Triggering and timebase</b> .....	27		
Automatic Peak (value) -Triggering .....	27		
Normal Triggering .....	27		
Slope $\int 1$ .....	27		
Trigger coupling .....	28		
Triggering of video signals .....	28		
Line triggering (~) .....	29		
Alternate triggering .....	29		
External triggering .....	29		
Trigger indicator „TR“ .....	29		
HOLD OFF-time adjustment .....	30		
<b>Delay / After Delay Triggering</b> .....	30		
<b>AUTO SET</b> .....	32		
<b>SAVE / RECALL</b> .....	32		
<b>Component Tester</b> .....	32		
General .....	32		
Using the Component Tester .....	33		
		<b>Test Instructions</b> .....	36
		General .....	36
		Cathode-Ray Tube .....	36
		Astigmatism Check .....	37
		Calibration of the Vertical Amplifier .....	37
		Transmission Performance of the Vertical Amplifier .....	37
		Operating Modes: .....	38
		Triggering Checks .....	38
		Timebase .....	38
		Hold Off time (analog mode only) .....	39
		Component Tester .....	39
		Trace Alignment .....	39
		<b>Service Instructions</b> .....	39
		General .....	39
		Instrument Case Removal .....	39
		Operating Voltages .....	39
		Maximum and Minimum Brightness .....	40
		Astigmatism control .....	40
		Trigger Threshold .....	40
		Trouble-Shooting the Instrument .....	40
		Adjustments .....	40
		<b>RS232 Interface - Remote Control</b> .....	41
		Safety .....	41
		Operation .....	41
		RS-232 Cable .....	41
		RS-232 protocol .....	41
		Baud-Rate Setting .....	41
		Data Communication .....	41
		<b>Front Panel HM305</b> .....	43

GB

## Oscilloscope HM305-2



KONFORMITÄTSERKLÄRUNG  
DECLARATION OF CONFORMITY  
DECLARATION DE CONFORMITE

**HAMEG®**  
Instruments

Herstellere  
Manufacturer  
Fabricant  
HAMEG GmbH  
Kelsterbacherstraße 15-19  
D - 60528 Frankfurt

Angewendete harmonisierte Normen / Harmonized standards applied / Normes harmonisées utilisées

Bezeichnung / Product name / Designation:  
Oszilloskop/Oscilloscope/Oscilloscope

Sicherheit / Safety / Sécurité

EN 61010-1: 1993 / IEC (CEI) 1010-1: 1990 A 1: 1992 / VDE 0411: 1994  
Überspannungskategorie / Overvoltage category / Catégorie de surtension: II  
Verschmutzungsgrad / Degree of pollution / Degré de pollution: 2

Typ / Type / Type: HM305-2

Elektromagnetische Verträglichkeit / Electromagnetic compatibility  
Compatibilité électromagnétique

mit / with / avec: -

EN 50082-2: 1995 / VDE 0839 T82-2  
ENV 50140: 1993 / IEC (CEI) 1004-4-3: 1995 / VDE 0847 T3  
ENV 50141: 1993 / IEC (CEI) 1000-4-6 / VDE 0843 / 6  
EN 61000-4-2: 1995 / IEC (CEI) 1000-4-2: 1995 / VDE 0847 T4-2  
Prüfschärfe / Level / Niveau = 2

Optionen / Options / Options:

mit den folgenden Bestimmungen / with applicable regulations / avec les directives suivantes

EMV Richtlinie 89/336/EWG ergänzt durch 91/263/EWG, 92/31/EWG  
EMC Directive 89/336/EEC amended by 91/263/EWG, 92/31/EEC  
Directive EMC 89/336/CEE amendée par 91/263/EWG, 92/31/CEE

EN 61000-4-4: 1995 / IEC (CEI) 1000-4-4: 1995 / VDE 0847 T4-4:  
Prüfschärfe / Level / Niveau = 3

EN 50081-1: 1992 / EN 55011: 1991 / CISPR11: 1991 / VDE0875 T11: 1992  
Gruppe / group / groupe = 1, Klasse / Class / Classe = B

Niederspannungsrichtlinie 73/23/EWG ergänzt durch 93/68/EWG  
Low-Voltage Equipment Directive 73/23/EEC amended by 93/68/EEC  
Directive des équipements basse tension 73/23/CEE amendée par 93/68/CEE

Datum / Date / Date  
14. 12. 1995

Unterschrift / Signature / Signatur

  
Dr. J. Herzog  
Technical Manager/Directeur Technique

### General information regarding the CE marking

HAMEG instruments fulfill the regulations of the EMC directive. The conformity test made by HAMEG is based on the actual generic- and product standards. In cases where different limit values are applicable, HAMEG applies the severer standard. For emission the limits for residential, commercial and light industry are applied. Regarding the immunity (susceptibility) the limits for industrial environment have been used.

The measuring- and data lines of the instrument have much influence on emission and immunity and therefore on meeting the acceptance limits. For different applications the lines and/or cables used may be different. For measurement operation the following hints and conditions regarding emission and immunity should be observed:

#### 1. Data cables

For the connection between instruments resp. their interfaces and external devices, (computer, printer etc.) sufficiently screened cables must be used. Without a special instruction in the manual for a reduced cable length, the maximum cable length of a dataline must be less than 3 meters long. If an interface has several connectors only one connector must have a connection to a cable.

Basically interconnections must have a double screening. For IEEE-bus purposes the double screened cables HZ72S and HZ72L from HAMEG are suitable.

#### 2. Signal cables

Basically test leads for signal interconnection between test point and instrument should be as short as possible. Without instruction in the manual for a shorter length, signal lines must be less than 3 meters long.

Signal lines must be screened (coaxial cable - RG58/U). A proper ground connection is required. In combination with signal generators double screened cables (RG223/U, RG214/U) must be used.

#### 3. Influence on measuring instruments.

Under the presence of strong high frequency electric or magnetic fields, even with careful setup of the measuring equipment an influence of such signals is unavoidable.

This will not cause damage or put the instrument out of operation. Small deviations of the measuring value (reading) exceeding the instruments specifications may result from such conditions in individual cases.

HAMEG GmbH

## Specifications

### Vertical Deflection

**Operating modes:** Channel I or CH II separate, Channel I and II: alternate or chopped (Chopper Frequency approx. 0.5MHz)

**Sum or Difference** from Channel I and Ch. II, (CH II invertable). **XY-Mode:** via CH I and CH II.

**Frequency range:** 2x DC to 35MHz (-3dB). Risettime: <10ns. Overshoot:  $\leq 1\%$ .

**Deflection coefficient:** 14 calibrated positions from 1mV/div to 20V/div in 1-2-5 sequence, variable 2.5:1 to min. **50V/div.**

Accuracy in calibrated positions:  
1mV/div to 2mV/div:  $\pm 5\%$  (0 to 10MHz (-3dB))  
5mV/div to 20V/div:  $\pm 3\%$

**Input impedance:** 1M $\Omega$  || 20pF.  
Input coupling: DC - AC - GD (Ground)  
Input voltage: max. 400V (DC + peak AC).

### Triggering

**Automatic** (peak to peak):  $\leq 20\text{Hz}$ -100MHz ( $\leq 0.5\text{div}$ ), Normal: **DC**-100MHz, LED for trigger indication.

**Slope:** positive or negative.

Sources: CH I or II, CH I alternate CH II, line, ext. Coupling: **AC** ( $\geq 10\text{Hz}$ -100MHz), **DC** (0-100MHz), **LF** (0 -  $\leq 1.5\text{kHz}$ ).

**Triggering ext.:**  $\geq 0.3\text{V}_{\text{pp}}$  from DC to 30MHz  
**Active TV-Sync-Separator** (field & line, pos. neg.)

**2nd triggering (Del. Trig.):** normal with level control DC to 100 MHz.

### Horizontal Deflection

**Time coefficients:** 1-2-5 sequence, Accuracy  $\pm 3\%$

**Analog:** 22 cal. positions from 0.5s - 50ns/div.

**Digital:** 25 cal. positions from 100s - 1 $\mu\text{s}$ /div.

Variable (analog) 2.5:1 up to 1.25s/div.

**X-MAG.x10:** analog to 10ns/div., dig. to 0.1 $\mu\text{s}$ /div  $\pm 5\%$ .

**Delay:** 120ms - 100ns, variable.

**Hold-off time** (analog): variable to approx. 10:1.

**Bandwidth X-amplifier** (analog): 0-3MHz ( $-3\text{dB}$ ).

Input X-amplifier via Channel II, Sensitivity see Channel II.

**X-Y-phase shift:**  $< 3^\circ$  below 220kHz.

### Digital Storage

**Operating modes:** Refresh, Roll, Single, XY, Envelope, Average (2 to 512 waveforms).

**Automatic Dot Join** function

**Sample Rate:** max. 100MS/s (8 bit)

**Refresh rate:** max. 180/s

**Record length:** 2048 x 8 bit per channel.

Reference memory: 2 x 2k x 8bit (EEPROM).

**Resolution:** Y: 25 points/div, X: 200 points/div.

**Pretrigger:** 0 or 50%

### Operation / Control

**Manual** (front panel switches);

**Auto Set** (automatic parameter selection).

**Save / Recall** of 10 user-defined parameter settings

**RS232 interface** for remote control via a PC.

Remote control (Option) **HZ68**.

**Multifunction-Interface** HM79-6(Option): RS232, IEEE-488, Centronics (Postscript, HPGL, PCL, EPSON).

**Readout:** Display of parameter settings.

**Cursor measurement** of  $\Delta V$ ,  $\Delta t$  or  $\Delta 1/t$  (frequency), separate or in tracking mode.

### Component Tester

**Test voltage:** approx. 8.5V<sub>rms</sub> (open circuit).

**Test current:** max. 7mA<sub>rms</sub> (short circuit).

**Test frequency:** approx. 50Hz

One test lead is grounded (Safety Earth).

### General Information

**CRT:** D14-364GY/123 or ER151-GH/-, rectangular screen (8x10cm) internal graticule

**Acceleration voltage:** approx 2000V

**Trace rotation:** adjustable on front panel

**Calibrator:** square-wave generator ( $t_r < 4\text{ns}$ )  $\approx 1\text{kHz}/1\text{MHz}$ ; Output: 0.2V  $\pm 1\%$ .

**Line voltage:** 100-240V AC  $\pm 10\%$ , 50/60Hz

**Power consumption:** approx. 46 Watt at 50Hz.

Min./Max. ambient temperature: 0°C...+40°C

**Protective system:** Safety class I (IEC1010-1)

Weight: approx. 6kg, color: techno-brown

Cabinet: W 285, H 125, D 380 mm

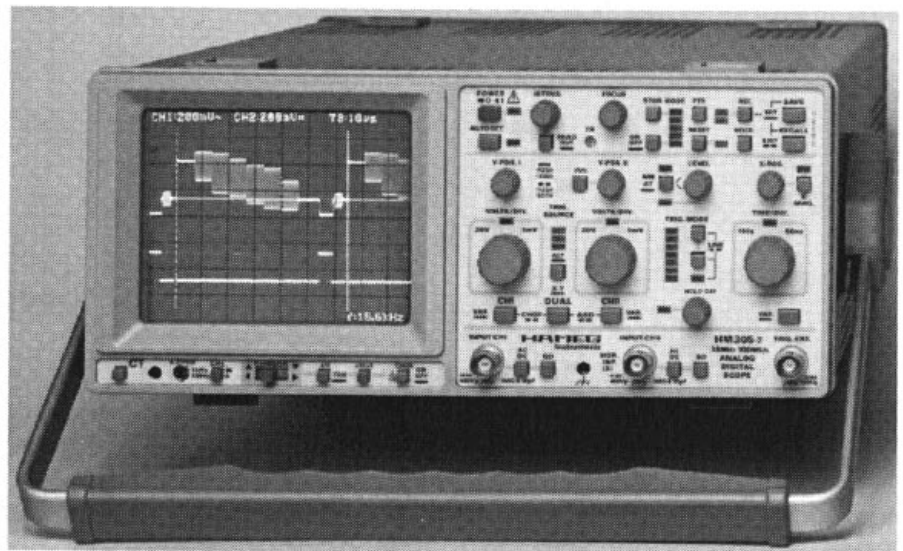

## 35MHz Analog-/Digital-Scope HM305-2

### Auto-Set, Save/Recall, Readout/Cursor, RS232 Interface

**Analog:** 2 x DC-35MHz, max. 1mV/div, Timebase 0.5s/div - 10ns/div

**Triggering** DC - 100MHz, Component Tester, 1MHz Calibrator

**Digital:** Max. Sampling Rate 100MS/s, Timebase 100s/div - 0.1 $\mu\text{s}$ /div

**Storage** 2 x 2048 x 8 bit, Reference Memory, Pre-Trigger 50%

**Storage Modes:** Refresh, Single, Roll, Average and Envelope

This latest version of the highly successful **HM305** offers all the standard features of **HAMEG's** new oscilloscope generation. The **HM305-2** now incorporates a **microprocessor-based** system that extensively automates operation. The majority of signals can be displayed by simply pressing the "Auto-set" button. A **"Save/Recall"** function is available for storing frequently used setup parameters.

The increased maximum sampling rate of **100MS/s** now allows to capture a **10MHz** signal in "Single" mode with **10 samples** (dots) per period. The **automatic Dot-Join** function provides linear connections between the captured points, ensuring that all digitized signals are displayed without gaps. New features are the **two reference memories**, allowing their contents to be compared with the live signal at any time. Cursors can be activated for waveform measurements. All important parameter settings are displayed on the CRT screen. The **built-in RS232-Interface** enables remote control operation and signal processing via a PC.

Unique in its price range is also the analog section of the **HM305-2**. The increased bandwidth of **35MHz** ( $-3\text{dB}$ ) allows the stable display of signals up to **100MHz**. As always, the **Component Tester** with one-button control is a standard feature in the **HM305-2**. This is also true for the switchable **1kHz/1MHz Calibrator** which permits you to check the transient characteristics from probe tip to the screen at any time.

All in all, the new **HM305-2** presents itself as a practical hands-on oscilloscope for today's progressive measurement requirements offering a price/performance ratio that sets new standards world-wide.

### Accessories supplied: Line Cord, Operators Manual, 2 Probes 1:1/ 10:1

Screen photo of stored sinewave signals.

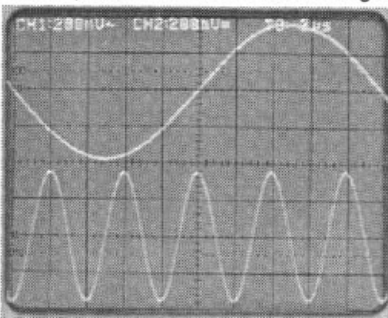

Screen shot of measurement software.

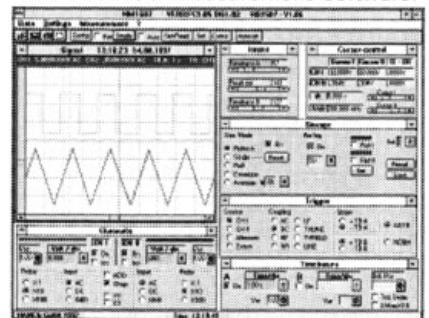

2/97

## HZ 56 AC/DC Current Probe

Utilising Hall Effect technology to provide a broad frequency response, the probe will accurately measure AC, DC and complex waveforms. The compact clip-on design conforms to the IEC1010 safety standard and allows non-intrusive measurement of current from 5mA to 30A peak to an accuracy of  $\pm 1\%$ . The probe gives a voltage output directly proportional to the measured current which is compatible with a wide range of measuring instruments.

### Specifications:

**Current range:** 20A<sub>DC</sub> / 30A<sub>AC</sub>  
**Accuracy:**  $\pm 1\% \pm 2\text{mA}$   
**Dielectric strength:** 3.7kV, 50Hz, 1min.  
**Output sensitivity:** 100mV/A

**Frequency range:** DC-100kHz  
**Resolution:**  $\pm 1\text{mA}$   
**Load impedance:**  $>100\text{k}\Omega$   
**Divers:** BNC-cable, 2m.

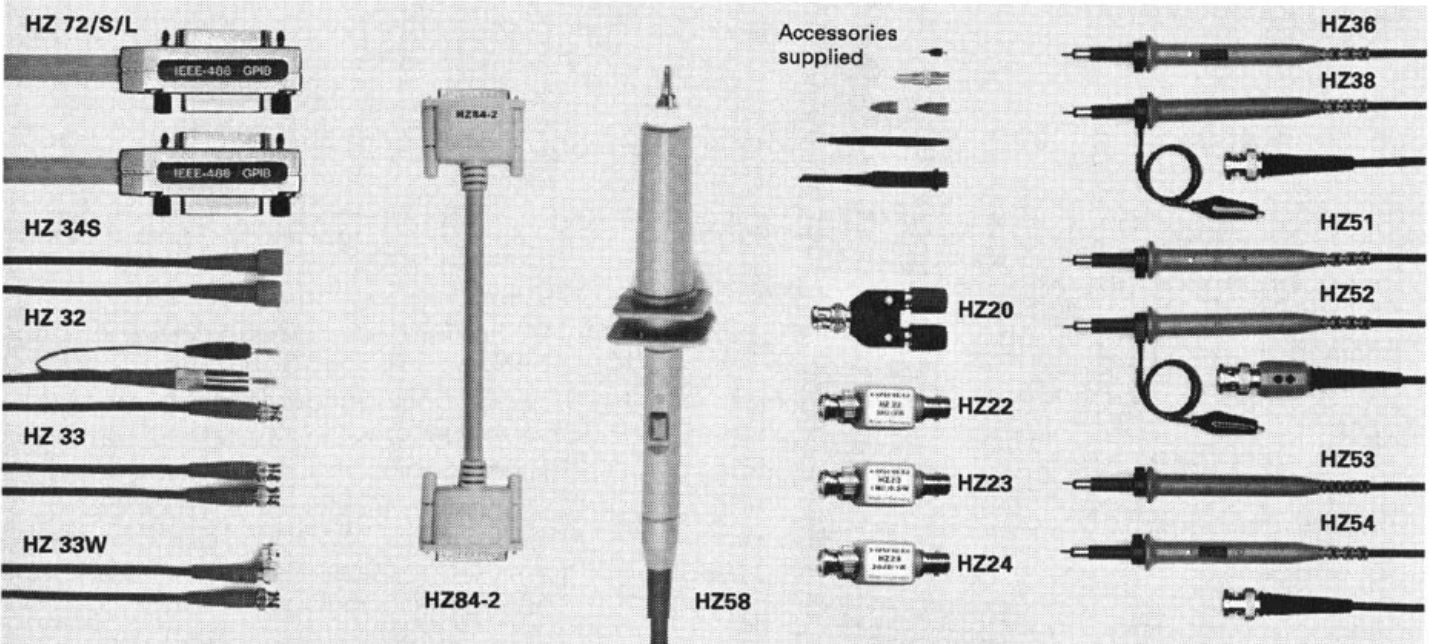
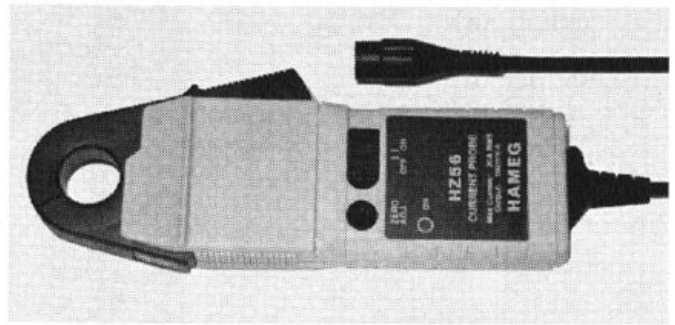

<b>HZ20</b>	Adaptor BNC to 4mm binding posts
<b>HZ22</b>	50 $\Omega$ BNC Feed-through termination 1GHz, 1W
<b>HZ23</b>	Attenuator 2:1, BNC male to BNC female, for oscilloscope service only.
<b>HZ24</b>	Set of 4 BNC 50 $\Omega$ attenuators; 3/6/10/20dB; 1GHz, 1W, incl. 1x HZ22

### Test Cables

<b>HZ32</b>	Test cable BNC to single stacking banana plugs; 40 inch
<b>HZ33</b>	Coaxial cable BNC/BNC, 50 $\Omega$ , 20 inch
<b>HZ33S</b>	Coaxial cable BNC/BNC, 50 $\Omega$ , 20 inch, insulated
<b>HZ33W</b>	Coaxial cable BNC/BNC, 50 $\Omega$ , 20 inch, elbow
<b>HZ34</b>	Coaxial cable BNC/BNC, 50 $\Omega$ , 40 inch
<b>HZ34S</b>	Coaxial cable BNC/BNC, 50 $\Omega$ , 40 inch, insulated
<b>HZ72S</b>	IEEE-488-Bus-Cable, 40 inch, double shielded
<b>HZ72L</b>	IEEE-488-Bus-Cable, 60 inch, double shielded
<b>HZ84-2</b>	Spare Printer Cable for HD148 (CE) and HM305 / 1007 (CE)
<b>HZ84-3</b>	Spare Printer Cable for combination of 25pole D-SUB / 26pole plastic male

### Wide Band Probes with RF alignment

Type	Attenuation Ratio	Bandwidth	Risetime	Input Impedance	Max. Input Voltage
<b>HZ36</b>	1:1/10:1	10/100MHz	<35/3.5ns	1/10M $\Omega$   57/12pF	(10:1) 600V (DC+peak AC)
<b>HZ51</b>	10:1	150MHz	<2.4ns	10M $\Omega$   12pF	600V (DC+peak AC)
<b>HZ52</b>	10:1	250MHz	<1.4ns	10M $\Omega$   10pF	600V (DC+peak AC)
<b>HZ53</b>	100:1	100MHz	<3.5ns	100M $\Omega$   4.5pF	1200V (DC+peak AC)
<b>HZ54</b>	1:1/10:1	10/150MHz	<35/2.4ns	1/10M $\Omega$   57/12pF	(10:1) 600V (DC+peak AC)

### Special Probes

<b>HZ38</b>	Demodulator Probe	0.1 - 500MHz	max. 200V (DC)
<b>HZ58</b>	High Voltage Probe, 1000:1; R <sub>i</sub> approx. 500M $\Omega$ ; DC - 1MHz		max. 15kV (DC+peak AC)

**HZ47** Viewing Hood for Oscilloscopes HM205, 408, 604-1+2, 1005 and 1007

**HZ48** Viewing Hood for Oscilloscopes 303, 304, 305, 604-3 and 1004

**HZ39** Spare Cable for HZ36  
**HZ57** Spare Cable for HZ51, HZ54  
*Spare-parts for modular probes only*  
**Spare-part Kit HZ40**

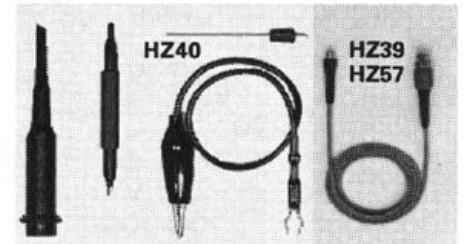

**HZ96** Carrying Case for oscilloscopes HM203, 205, 208, 408, 604, 1005 and 1007

**HZ97** Carrying Case for HM303, 304, 305, 604-3, 1004 and HM5005 / 6 / 10.

The carrying case provides protection during transportation of an oscilloscope. It is made of a durable vinyl-coated material that is designed to withstand the stress and wear and tear of field use.





05/96

## General Information

This oscilloscope is easy to operate. The logical arrangement of the controls allows anyone to quickly become familiar with the operation of the instrument, however, experienced users are also advised to read through these instructions so that all functions are understood.

Immediately after unpacking, the instrument should be checked for mechanical damage and loose parts in the interior. If there is transport damage, the supplier must be informed immediately. The instrument must then not be put into operation.

## Symbols

-  ATTENTION - refer to manual
-  Danger - High voltage
-  Protective ground (earth) terminal

### Use of tilt handle

To view the screen from the best angle, there are three different positions (C, D, E) for setting up the instrument. If the instrument is set down on the floor after being carried, the handle automatically remains in the upright carrying position (A). In order to place the instrument onto a horizontal surface, the handle should be turned to the upper side of the oscilloscope (C). For the D position (10° inclination), the handle should be turned to the opposite direction of the carrying position until it locks in place automatically underneath the instrument. For the E position (20° inclination), the handle should be pulled to release it from the D position and swing backwards until it locks once more. The handle may also be set to a position for horizontal carrying by turning it to the upper side to lock in the B position. At the same time, the instrument must be lifted, because otherwise the handle will jump back.

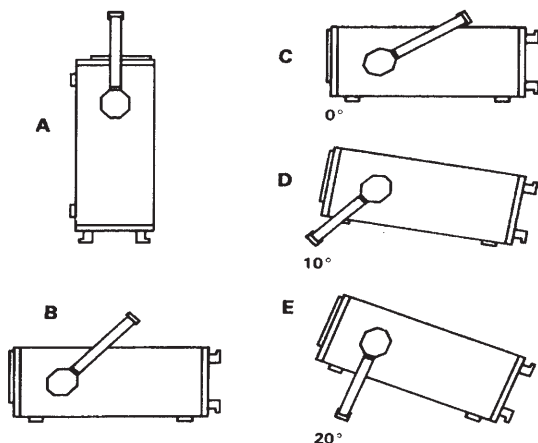

### Safety

This instrument has been designed and tested in accordance with **IEC Publication 1010-1** (overvoltage category II, pollution degree 2), Safety requirements for electrical equipment for measurement, control, and laboratory use. The CENELEC regulations EN 61010-1 correspond to this standard. It has left the factory in a safe condition. This instruction manual contains important information and warnings which have to be followed by the user to ensure

safe operation and to retain the oscilloscope in a safe condition. The case, chassis and all measuring terminals are connected to the protective earth contact of the appliance inlet. The instrument operates according to Safety Class I (three-conductor power cord with protective earthing conductor and a plug with earthing contact).

The mains/line plug shall only be inserted in a socket outlet provided with a protective earth contact. The protective action must not be negated by the use of an extension cord without a protective conductor.

**The mains/line plug must be inserted before connections are made to measuring circuits.**

The grounded accessible metal parts (case, sockets, jacks) and the mains/line supply contacts (line/live, neutral) of the instrument have been tested against insulation breakdown with 2200V DC.

Under certain conditions, 50Hz or 60Hz hum voltages can occur in the measuring circuit due to the interconnection with other mains/line powered equipment or instruments. This can be avoided by using an isolation transformer (Safety Class II) between the mains/line outlet and the power plug of the device being investigated.

Most cathode-ray tubes develop X-rays. **However, the dose equivalent rate falls far below the maximum permissible value of 36pA/kg (0.5mR/h).**

Whenever it is likely that protection has been impaired, the instrument shall be made inoperative and be secured against any unintended operation. The protection is likely to be impaired if, for example, the instrument

- shows visible damage,
- fails to perform the intended measurements,
- has been subjected to prolonged storage under unfavourable conditions (e.g. in the open or in moist environments),
- has been subject to severe transport stress (e.g. in poor packaging).

### Intended purpose and operating conditions

This instrument must be used only by qualified experts who are aware of the risks of electrical measurement.

The instrument is specified for operation in industry, light industry, commercial and residential environments.

Due to safety reasons the instrument must only be connected to a properly installed power outlet, containing a protective earth conductor. The protective earth connection must not be broken. The power plug must be inserted in the power outlet while any connection is made to the test device.

The instrument has been designed for indoor use. The permissible ambient temperature range during operation is +10°C (+50°F) ... +40°C (+104°F). It may occasionally be subjected to temperatures between +10°C (+50°F) and -10°C (+14°F) without degrading its safety. The permissible ambient temperature range for storage or transportation is -40°C (-40°F) ... +70°C (+158°F). The maximum operating altitude is up to 2200m (non-operating 15000m). The maximum relative humidity is up to 80%.

## General Information

If condensed water exists in the instrument it should be acclimatized before switching on. In some cases (e.g. extremely cold oscilloscope) two hours should be allowed before the instrument is put into operation. The instrument should be kept in a clean and dry room and must not be operated in explosive, corrosive, dusty, or moist environments. The oscilloscope can be operated in any position, but the convection cooling must not be impaired. The ventilation holes may not be covered. For continuous operation the instrument should be used in the horizontal position, preferably tilted upwards, resting on the tilt handle.

**The specifications stating tolerances are only valid if the instrument has warmed up for 30 minutes at an ambient temperature between +15°C (+59°F) and +30°C (+86°F). Values without tolerances are typical for an average instrument.**

## EMC

This instrument conforms to the European standards regarding the electromagnetic compatibility. The applied standards are: Generic immunity standard EN50082-2:1995 (for industrial environment) Generic emission standard EN50081-1:1992 (for residential, commercial and light industry environment).

This means that the instrument has been tested to the highest standards.

Please note that under the influence of strong electromagnetic fields, such signals may be superimposed on the measured signals.

Under certain conditions this is unavoidable due to the instrument's high input sensitivity, high input impedance and bandwidth. Shielded measuring cables, shielding and earthing of the device under test may reduce or eliminate those effects.

## Warranty

HAMEG warrants to its Customers that the products it manufactures and sells will be free from defects in materials and workmanship **for a period of 2 years**. This warranty shall not apply to any defect, failure or damage caused by improper use or inadequate maintenance and care. HAMEG shall not be obliged to provide service under this warranty to repair damage resulting from attempts by personnel other than HAMEG representatives to install, repair, service or modify these products.

In order to obtain service under this warranty, Customers must contact and notify the distributor who has sold the product. Each instrument is subjected to a quality test with 10 hour burn-in before leaving the production. Practically all early failures are detected by this method. In the case of shipments by post, rail or carrier it is recommended that the original packing is carefully preserved. Transport damages and damage due to gross negligence are not covered by the guarantee.

In the case of a complaint, a label should be attached to the housing of the instrument which describes briefly the faults observed. If at the same time the name and telephone number (dialing code and telephone or direct number or department designation) is stated for possible queries, this helps towards speeding up the processing of guarantee claims.

## Maintenance

Various important properties of the oscilloscope should be carefully checked at certain intervals. Only in this way is it largely certain that all signals are displayed with the accuracy on which the technical data are based. The test methods described in the test plan of this manual can be performed without great expenditure on measuring instruments. However, purchase of the **HAMEG scope tester HZ 60**, which despite its low price is highly suitable for tasks of this type, is very much recommended. The exterior of the oscilloscope should be cleaned regularly with a dusting brush. Dirt which is difficult to remove on the casing and handle, the plastic and aluminium parts, can be removed with a moistened cloth (99% water + 1% mild detergent). Spirit or washing benzine (petroleum ether) can be used to remove greasy dirt. The screen may be cleaned with water or washing benzine (but not with spirit (alcohol) or solvents), it must then be wiped with a dry clean lint-free cloth. Under no circumstances may the cleaning fluid get into the instrument. The use of other cleaning agents can attack the plastic and paint surfaces.

## Protective Switch-Off

This instrument is equipped with a switch mode power supply. It has both overvoltage and overload protection, which will cause the switch mode supply to limit power consumption to a minimum. In this case a ticking noise may be heard.

## Power supply

The oscilloscope operates on mains/line voltages between 100VAC and 240VAC. No means of switching to different input voltages has therefore been provided.

The power input fuses are externally accessible. The fuseholder is located above the 3-pole power connector. The power input fuses are externally accessible, if the rubber connector is removed. The fuseholder can be released by pressing its plastic retainers with the aid of a small screwdriver. The retainers are located on the right and left side of the holder and must be pressed towards the center. The fuse(s) can then be replaced and pressed in until locked on both sides.

Use of patched fuses or short-circuiting of the fuseholder is not permissible; HAMEG assumes no liability whatsoever for any damage caused as a result, and all warranty claims become null and void.

### Fuse type:

Size 5x20mm; **0.8A**, 250V AC fuse; must meet IEC specification 127, Sheet III (or DIN 41 662 or DIN 41 571, sheet 3).

Time characteristic: **time-lag (T)**.

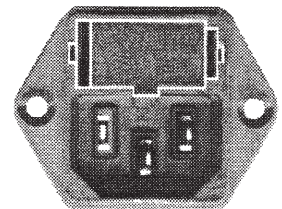

### Attention!

There is a fuse located inside the instrument within the switch mode power supply:

Size 5x20mm; **0.8A**, 250V AC fuse; must meet IEC specification 127, Sheet III (or DIN 41 662 or DIN 41 571, sheet 3).

Time characteristic: **fast (F)**.

**This fuse must not be replaced by the operator!**

## Type of signal voltage

The following description of the **HM305-2** relates to the analog-oscilloscope mode. Please note „**Storage Operation**“.

The oscilloscope **HM305-2** allows examination of **DC** voltages and most repetitive signals in the frequency range up to at least **35MHz (-3dB)**.

The vertical amplifiers have been designed for minimum overshoot and therefore permit a true signal display.

The display of sinusoidal signals within the bandwidth limits causes no problems, but an increasing error in measurement due to gain reduction must be taken into account when measuring high frequency signals. This error becomes noticeable at approx. **14MHz**. At approx. **18MHz** the reduction is approx. 10% and the real voltage value is 11% higher. The gain reduction error can not be defined exactly as the **-3dB** bandwidth of the amplifiers differ between **35MHz** and **38MHz**.

**For sinewave signals the -6dB limit is approx. 50MHz.**

When examining square or pulse type waveforms, attention must be paid to the harmonic content of such signals. The repetition frequency (fundamental frequency) of the signal must therefore be significantly smaller than the upper limit frequency of the vertical amplifier.

Displaying composite signals can be difficult, especially if they contain no repetitive higher amplitude content which can be used for triggering. This is the case with bursts, for instance. To obtain a well-triggered display in this case, the assistance of the variable holdoff function or the delayed timebase may be required. Television video signals are relatively easy to trigger using the built-in **TV-Sync-Separator (TV)**.

For optional operation as a **DC** or **AC** voltage amplifier, each vertical amplifier input is provided with a **DC/AC** switch. DC coupling should only be used with a series-connected attenuator probe or at very low frequencies or if the measurement of the DC voltage content of the signal is absolutely necessary.

When displaying very low frequency pulses, the flat tops may be sloping with AC coupling of the vertical amplifier (AC limit frequency approx. 1.6 Hz for 3dB). In this case, DC operation is preferred, provided the signal voltage is not superimposed on a too high DC level. Otherwise a capacitor of adequate capacitance must be connected to the input of the vertical amplifier with DC coupling. This capacitor must have a sufficiently high breakdown voltage rating. DC coupling is also recommended for the display of logic and pulse signals, especially if the pulse duty factor changes constantly. Otherwise the display will move upwards or downwards at each change. Pure direct voltages can only be measured with DC-coupling.

The input coupling is selectable by the AC/DC pushbutton. The actual setting is displayed in the readout with the „ = „ symbol for DC- and the „ ~ „ symbol for AC coupling.

## Amplitude Measurements

In general electrical engineering, alternating voltage data normally refers to effective values (rms = root-mean-square value). However, for signal magnitudes and voltage designations in oscilloscope measurements, the peak-to-peak voltage ( $V_{pp}$ ) value is applied. The latter corresponds to the real potential difference between the most positive and most negative points of a signal waveform. If a sinusoidal waveform, displayed on the oscilloscope screen, is to be converted into an effective (rms) value, the resulting peak-to-peak value must be divided by  $2\sqrt{2} = 2.83$ . Conversely, it should be observed that sinusoidal voltages indicated in  $V_{rms}$  ( $V_{eff}$ ) have 2.83 times the potential difference in  $V_{pp}$ . The relationship between the different voltage magnitudes can be seen from the following figure.

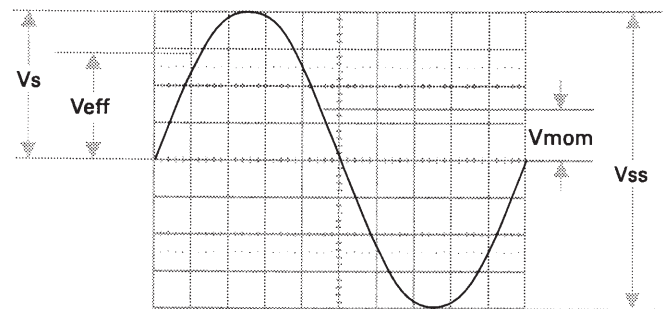

## Voltage values of a sine curve

$V_{rms}$  = effective value;  
 $V_p$  = simple peak or crest value;  
 $V_{pp}$  = peak-to-peak value;  
 $V_{mom}$  = momentary value.

The minimum signal voltage which must be applied to the Y input for a trace of 1div height is  $1mV_{pp}$  ( $\pm 5\%$ ) when this deflection coefficient is displayed on the screen (readout) and the vernier is switched off (VAR-LED dark). However, smaller signals than this may also be displayed. The deflection coefficients are indicated in mV/div or V/div (peak-to-peak value).

The magnitude of the applied voltage is ascertained by multiplying the selected deflection coefficient by the vertical display height in div. If an attenuator probe  $\times 10$  is used, a further multiplication by a factor of 10 is required to ascertain the correct voltage value.

**For exact amplitude measurements, the variable control (VAR) must be set to its calibrated detent CAL position.**

With the variable control activated the deflection sensitivity can be reduced up to a ratio of 2.5 to 1 (please note „**controls and readout**“). Therefore any intermediate value is possible within the 1-2-5 sequence of the attenuator(s).

**With direct connection to the vertical input, signals up to  $400V_{pp}$  may be displayed (attenuator set to  $20V/div$ , variable control to 2.5:1).**



## Type of signal voltage

With the designations

- H** = display height in div,
- U** = signal voltage in Vpp at the vertical input,
- D** = deflection coefficient in V/div at attenuator switch,

the required value can be calculated from the two given quantities:

$$U = D \cdot H \quad H = \frac{U}{D} \quad D = \frac{U}{H}$$

However, these three values are not freely selectable. They have to be within the following limits (trigger threshold, accuracy of reading):

- H** between 0.5 and 8div, if possible 3.2 to 8div,
- U** between 1mVpp and 160Vpp,
- D** between 1mV/div and 20V/div in 1-2-5 sequence.

It should be noted that its AC peak value is derated at higher frequencies. If a normal x10 probe is used to measure high voltages there is the risk that the compensation trimmer bridging the attenuator series resistor will break down causing damage to the input of the oscilloscope. However, if for example only the residual ripple of a high voltage is to be displayed on the oscilloscope, a normal x10 probe is sufficient. In this case, an appropriate high voltage capacitor (approx. 22-68nF) must be connected in series with the input tip of the probe.

With **Y-POS.** control (input coupling to **GD**) it is possible to use a **horizontal graticule line as reference line for ground potential before the measurement.** It can lie below or above the horizontal central line according to whether positive and/or negative deviations from the ground potential are to be measured.

### Total value of input voltage

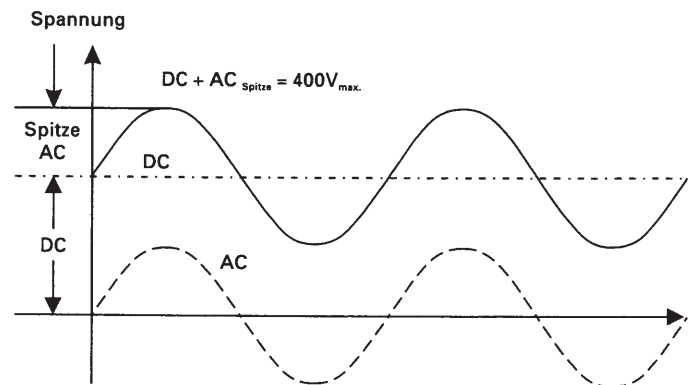

The dotted line shows a voltage alternating at zero volt level. If superimposed on a DC voltage, the addition of the positive peak and the DC voltage results in the max. voltage (DC + ACpeak).

### Time Measurements

As a rule, most signals are to be displayed as periodically repeating processes, also called periods. The number of periods per second is the repetition frequency. Depending on the timebase setting (**TIME/DIV.**-knob) indicated by the readout, one or several signal periods or only a part of a period can be displayed. The time coefficients are stated in **ms/div**, **µs/div** or **ns/div**. The following examples are related to the CRT graticule reading. The results can also be determined with the aid of the  $\Delta T$  and  $1/\Delta T$  cursor measurement (**please note „controls and readout“**).

**The duration of a signal period or a part of it is determined by multiplying the relevant time (horizontal distance in div) by the (calibrated) time coefficient displayed in the readout. Uncalibrated, the timebase speed can be reduced until a maximum factor of 2.5 is reached. Therefore any intermediate value is possible within the 1-2-5 sequence.**

### With the designations

- L** = displayed wave length in div of one period,
- T** = time in seconds for one period,
- F** = recurrence frequency in Hz of the signal,
- Tc** = time coefficient in ms, µs or ns/div and the relation
- F** = 1/T, the following equations can be stated:

$$T = L \cdot Tc \quad L = \frac{T}{Tc} \quad Tc = \frac{T}{L}$$

$$F = \frac{1}{L \cdot Tc} \quad L = \frac{1}{F \cdot Tc} \quad Tc = \frac{1}{L \cdot F}$$

### Examples:

Set deflection coefficient **D** = 50mV/div 0.05V/div, observed display height **H** = 4.6div, required voltage **U** = 0.05x4.6 = 0.23Vpp.

Input voltage **U** = 5Vpp, set deflection coefficient **D** = 1V/div, required display height **H** = 5:1 = 5div.

Signal voltage **U** = 230Vrmsx $\sqrt{2}$  = 651Vpp (voltage > 160Vpp, with probe 10:1: **U** = 65.1Vpp), desired display height **H** = min. 3.2div, max. 8div, max. deflection coefficient **D** = 65.1:3.2 = 20.3V/div, min. deflection coefficient **D** = 65.1:8 = 8.1V/div, adjusted deflection coefficient **D** = 10V/div.

The previous examples are related to the CRT graticule reading. The results can also be determined with the aid of the DV cursor measurement (please note „controls and readout“).

**The input voltage must not exceed 400V, independent from the polarity.**

If an AC voltage which is superimposed on a DC voltage is applied, the maximum peak value of both voltages must not exceed + or - 400V. So for AC voltages with a mean value of zero volt the maximum peak to peak value is 800V<sub>pp</sub>.

**If attenuator probes with higher limits are used, the probes limits are valid only if the oscilloscope is set to DC input coupling.**

If DC voltages are applied under AC input coupling conditions the oscilloscope maximum input voltage value remains 400V. The attenuator consists of a resistor in the probe and the 1MΩ input resistor of the oscilloscope, which are disabled by the AC input coupling capacity when AC coupling is selected. This also applies to DC voltages with superimposed AC voltages. It also must be noted that due to the capacitive resistance of the AC input coupling capacitor, the attenuation ratio depends on the signal frequency. For sinewave signals with frequencies higher than 40Hz this influence is negligible.

With the above listed exceptions **HAMEG** 10:1 probes can be used for DC measurements up to 600V or AC voltages (with a mean value of zero volt) of 1200V<sub>pp</sub>. The 100:1 probe HZ53 allows for 1200V DC or 2400V<sub>pp</sub> for AC.

However, these four values are not freely selectable. They have to be within the following limits:

- L** between 0.2 and 10div, if possible 4 to 10div,
- T** between 10ns and 5s,
- F** between 0.5Hz and 100MHz,
- Tc** between 50ns/div and 500ms/div in 1-2-5 sequence (with X-MAG. (x10) inactive), and
- Tc** between 10ns/div and 50ms/div in 1-2-5 sequence (with X-MAG. (x10) active).

**Examples:**

Displayed wavelength  $L = 7$  div,  
 set time coefficient  $Tc = 100$ ns/div,  
 required period  $T = 7 \times 100 \times 10^{-9} = 0.7 \mu s$   
 required rec. freq.  $F = 1 : (0.7 \times 10^{-6}) = 1.428$  MHz.

Signal period  $T = 1$  s,  
 set time coefficient  $Tc = 0.2$  s/div,  
 required wavelength  $L = 1 : 0.2 = 5$  div.

Displayed ripple wavelength  $L = 1$  div,  
 set time coefficient  $Tc = 10$  ms/div,  
 required ripple freq.  $F = 1 : (1 \times 10 \times 10^{-3}) = 100$  Hz.

TV-line frequency  $F = 15625$  Hz,  
 set time coefficient  $Tc = 10 \mu s$ /div,  
 required wavelength  $L = 1 : (15625 \times 10^{-5}) = 6.4$  div.

Sine wavelength  $L = \text{min. } 4 \text{ div, max. } 10 \text{ div,}$   
 Frequency  $F = 1$  kHz,  
 max. time coefficient  $Tc = 1 : (4 \times 10^3) = 0.25$  ms/div,  
 min. time coefficient  $Tc = 1 : (10 \times 10^3) = 0.1$  ms/div,  
 set time coefficient  $Tc = 0.2$  ms/div,  
 required wavelength  $L = 1 : (10^3 \times 0.2 \times 10^{-3}) = 5$  div.

Displayed wavelength  $L = 0.8$  div,  
 set time coefficient  $Tc = 0.5 \mu s$ /div,  
 pressed X-MAG. (x10) button:  $Tc = 0.05 \mu s$ /div,  
 required rec. freq.  $F = 1 : (0.8 \times 0.05 \times 10^{-6}) = 25$  MHz,  
 required period  $T = 1 : (25 \times 10^6) = 40$  ns.

If the time is relatively short as compared with the complete signal period, an expanded time scale should always be applied (X-MAG. (x10) active). In this case, the time interval of interest can be shifted to the screen center using the X-POS. control.

When investigating pulse or square waveforms, the critical feature is the risetime of the voltage step. To ensure that transients, ramp-offs, and bandwidth limits do not unduly influence the measuring accuracy, the risetime is generally measured between 10% and 90% of the vertical pulse height. For measurement, adjust the Y deflection coefficient using its variable function (uncalibrated) together with the Y-POS. control so that the pulse height is precisely aligned with the 0% and 100% lines of the internal graticule. The 10% and 90% points of the signal will now coincide with the 10% and 90% graticule lines. The risetime is given by the product of the horizontal distance in div between these two coinci-

dent points and the calibrated time coefficient setting. The fall time of a pulse can also be measured by using this method. The following figure shows correct positioning of the oscilloscope trace for accurate risetime measurement.

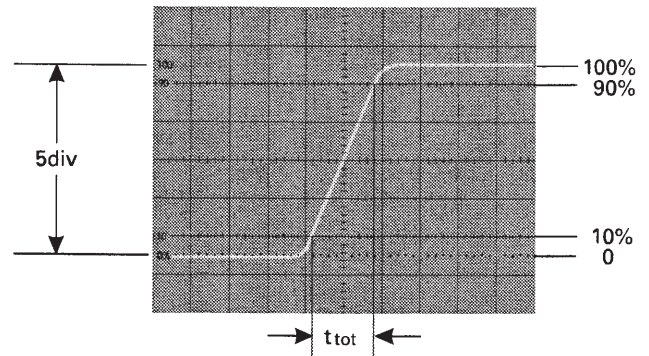

With a time coefficient of 10ns/div (X x10 magnification active), the example shown in the above figure results in a total measured risetime of

$$t_{tot} = 1,6 \times 10 \text{ ns/div} = 16 \text{ ns}$$

When very fast risetimes are being measured, the risetimes of the oscilloscope amplifier and of the attenuator probe has to be deducted from the measured time value. The risetime of the signal can be calculated using the following formula.

$$t_r = \sqrt{t_{tot}^2 - t_{osc}^2 - t_p^2}$$

In this  $t_{tot}$  is the total measured risetime,  $t_{osc}$  is the risetime of the oscilloscope amplifier (approx. 10ns), and  $t_p$  the risetime of the probe (e.g. = 2ns). If  $t_{tot}$  is greater than 100ns, then  $t_{tot}$  can be taken as the risetime of the pulse, and calculation is unnecessary.

Calculation of the example in the figure above results in a signal risetime

$$t_r = \sqrt{16^2 - 10^2 - 2^2} = 12,6 \text{ ns}$$

The measurement of the rise or fall time is not limited to the trace dimensions shown in the above diagram. It is only particularly simple in this way. In principle it is possible to measure in any display position and at any signal amplitude. It is only important that the full height of the signal edge of interest is visible in its full length at not too great steepness and that the horizontal distance at 10% and 90% of the amplitude is measured. If the edge shows rounding or overshooting, the 100% should not be related to the peak values but to the mean pulse heights. Breaks or peaks (glitches) next to the edge are also not taken into account. With very severe transient distortions, the rise and fall time measurement has little meaning. For amplifiers with approximately constant group delay (therefore good pulse transmission performance) the following numerical relationship between rise time **tr (in ns)** and bandwidth **B (in MHz)** applies:

$$t_r = \frac{350}{B} \quad B = \frac{350}{t_r}$$

## Connection of Test Signal

***In most cases briefly depressing the AUTO SET causes a useful signal related instrument setting. The following explanations refer to special applications and/or signals, demanding a manual instrument setting. The description of the controls is explained in the section „controls and readout“.***

**Caution:**

***When connecting unknown signals to the oscilloscope input, always use automatic triggering and set the input coupling switch to AC (readout). The attenuator should initially be set to 20V/div.***

Sometimes the trace will disappear after an input signal has been applied. Then a higher deflection coefficient (lower input sensitivity) must be chosen until the vertical signal height is only 3-8div. With a signal amplitude greater than 160Vpp and the deflection coefficient (**VOLTS/DIV.**) in calibrated condition, an attenuator probe must be inserted before the vertical input. If, after applying the signal, the trace is nearly blanked, the period of the signal is probably substantially longer than the set time deflection coefficient (**TIME/DIV.**). It should be switched to an adequately larger time coefficient. The signal to be displayed can be connected directly to the Y-input of the oscilloscope with a shielded test cable such as HZ32 or HZ34, or reduced through a x10 or x100 attenuator probe. The use of test cables with high impedance circuits is only recommended for relatively low frequencies (up to approx. 50kHz). For higher frequencies, the signal source must be of low impedance, i.e. matched to the characteristic resistance of the cable (as a rule 50Ω). Especially when transmitting square and pulse signals, a resistor equal to the characteristic impedance of the cable must also be connected across the cable directly at the Y-input of the oscilloscope. When using a 50Ω cable such as the HZ34, a 50Ω through termination type HZ22 is available from HAMEG. When transmitting square signals with short rise times, transient phenomena on the edges and top of the signal may become visible if the correct termination is not used. A terminating resistance is sometimes recommended with sine signals as well. Certain amplifiers, generators or their attenuators maintain the nominal output voltage independent of frequency only if their connection cable is terminated with the prescribed resistance. Here it must be noted that the terminating resistor HZ22 will only dissipate a maximum of 2Watts. This power is reached with 10V<sub>rms</sub> or at 28.3V<sub>pp</sub> with sine signal. If a x10 or x100 attenuator probe is used, no termination is necessary. In this case, the connecting cable is matched directly to the high impedance input of the oscilloscope. When using attenuator probes, even high internal impedance sources are only slightly loaded (approx. 10MΩ || 12pF or 100MΩ || 5pF with HZ53). Therefore, if the voltage loss due to the attenuation of the probe can be compensated by a higher amplitude setting, the probe should always be used. The series impedance of the probe provides a certain amount of protection for the input of the vertical amplifier. Because of their separate manufacture, all attenuator probes are only partially compen-

sated, therefore accurate compensation must be performed on the oscilloscope (**see Probe compensation**).

Standard attenuator probes on the oscilloscope normally reduce its bandwidth and increase the rise time. In all cases where the oscilloscope bandwidth must be fully utilized (e.g. for pulses with steep edges) we strongly advise using the probes HZ51 (x10) HZ52 (x10 HF) and HZ54 (x1 and x10). This can save the purchase of an oscilloscope with larger bandwidth.

The probes mentioned have a HF-calibration in addition to low frequency calibration adjustment. Thus a group delay correction to the upper limit frequency of the oscilloscope is possible with the aid of an 1MHz calibrator, e.g. HZ60.

In fact the bandwidth and rise time of the oscilloscope are not noticeably changed with these probe types and the waveform reproduction fidelity can even be improved because the probe can be matched to the oscilloscope's individual pulse response.

***If a x10 or x100 attenuator probe is used, DC input coupling must always be used at voltages above 400V. With AC coupling of low frequency signals, the attenuation is no longer independent of frequency, pulses can show pulse tilts. Direct voltages are suppressed but load the oscilloscope input coupling capacitor concerned. Its voltage rating is max. 400 V (DC + peak AC). DC input coupling is therefore of quite special importance with a x100 attenuation probe which usually has a voltage rating of max. 1200 V (DC + peak AC). A capacitor of corresponding capacitance and voltage rating may be connected in series with the attenuator probe input for blocking DC voltage (e.g. for hum voltage measurement).***

With all attenuator probes, **the maximum AC input voltage** must be derated with frequency usually above 20kHz. Therefore the derating curve of the attenuator probe type concerned must be taken into account.

The selection of the ground point on the test object is important when displaying small signal voltages. It should always be as close as possible to the measuring point. If this is not done, serious signal distortion may result from spurious currents through the ground leads or chassis parts. The ground leads on attenuator probes are also particularly critical. They should be as short and thick as possible. When the attenuator probe is connected to a BNC-socket, a BNC-adaptor, should be used. In this way ground and matching problems are eliminated. Hum or interference appearing in the measuring circuit (especially when a small deflection coefficient is used) is possibly caused by multiple grounding because equalizing currents can flow in the shielding of the test cables (voltage drop between the protective conductor connections, caused by external equipment connected to the mains/line, e.g. signal generators with interference protection capacitors).

# Controls and Readout

The following description assumes that the operating mode „COMPONENT TEST“ is switched off.

All important measuring parameter settings are displayed in the screen Readout when the oscilloscope is on. The LED indicators on the large front panel facilitate operation and provide additional information. Electrical end positions of controls are indicated by acoustic signal (beep).

All controls, except the power switch (POWER), the calibration frequency pushbutton (CAL. 1kHz/1MHz), the FOCUS control and the trace rotation control, are electronically set and interrogated. Thus, all electronically set functions and their current settings can be stored and also remotely controlled. Some controls are only operative in the digital mode or have a different function. Explanations pertaining to them are indicated by the hint „only in digital mode“.

The large front panel is, as is usual with Hameg oscilloscopes, marked with several fields.

The following controls and LED indicators are located on the top, to the right of the screen, above the horizontal line:

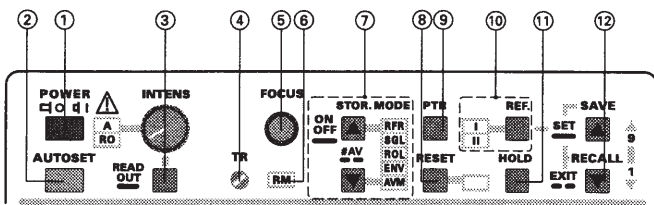

- (1) **POWER** - Power push switch with the symbols for ON (I) and OFF (O).

When the oscilloscope is switched on, all LED indicators light up and an automatic instrument test is performed. The HAMEG logo and the software version are displayed on the screen during this time. After the successful completion of the tests the logo disappears and the instrument switches to normal operating mode. The settings last used before switching off are taken over and a LED indicates the ON state.

It is possible to modify certain functions (**SETUP**) or to call automatic calibration procedures (**CALIBRATE**). For details relating to this see section „MENU“.

- (2) **AUTO SET** - This pushbutton performs an automatic setting of the controls depending on the signal. (see AUTO SET). Even if COMPONENT TEST or XY mode is currently selected, the AUTO SET switches to the Yt mode last used (CH I, CH II or DUAL).

Besides, the cursors will be switched off. See also **AUTO SET**.

**Only in digital mode.**

Additionally, AUTO SET automatically selects refresh mode (RFR) when SINGLE (SGL) or ROLL (ROL) function is in operation.

- (3) **INTENS** - rotary control with the corresponding LED's and the **READOUT** pushbutton below it.

The intensity (brightness) of the trace and the Readout can be set with the rotary switch. Turning the knob clockwise or anticlockwise increases or decreases the intensity respectively.

Associated with the rotary control **INTENS** are the LED **A** for the signal and LED **RO** for the Readout. The INTENS switch functions as trace or Readout intensity control depending on LED **A** or LED **RO** is lit. If the Readout is not switched off, then briefly pressing the pushbutton **READOUT** switches over to the other function.

The Readout can be switched on or off by pressing the **READOUT pushbutton** longer. Switching off the Readout avoids interference distortions such as are possible in the chopped (analog) DUAL mode. If the Readout is switched off when the **RO** LED is on, then this LED is switched off and the LED **A** lights up.

The trace intensity remains stored when the instrument is switched off. The last setting is therefore available when the unit is switched on again.

Operating the **AUTO SET** button sets the trace intensity to the middle value if it was previously set to a lower value.

- (4) **TR** - Trace rotation is adjusted with a small screwdriver (see **Trace rotation TR**).
- (5) **FOCUS** - rotary switch for setting focus; effects both the trace and the Readout.
- (6) **RM** - remote control. LED lights up when the instrument is switched over to the remote control mode through the **RS232** interface. The electronically set controls of the oscilloscope are not operative anymore. This state can be repealed by pressing the **AUTO SET** button providing this function is not also locked through the **RS232** interface.

**Only in digital mode.**

The **RM** LED lights up when a data transmission is in progress over the **RS-232** interface. During this time the oscilloscope cannot be operated.

- (7) **STOR. MODE** - Pushbutton with the associated LED scale.

Switching between analog and digital (store) operation is effected by pressing long the upper of the two pushbuttons (**ON / OFF**). For additional information regarding the digital mode, see section **STORAGE OPERATION**.

The oscilloscope is in analog mode if none of the LED's associated with the pushbuttons are lit. Pressing the button **ON / OFF** longer switches over to the digital mode, but without changing the channel operating mode (CH I, CH II, DUAL, ADD and XY). The instrument is set to the last used operating conditions with the exception of XY operation (**only RFR**) and the corresponding LED lights up. The term "Digital-mode" includes the signal capture modes (**RFR - SGL - ROL - ENV - AVM**), the pretrigger and post-trigger (**PTR** (9)) and the status of the Reference signal display (**REF.** (10)).

**Attention!**  
*The time base ranges are dependent on the operating mode Analog or Digital (storage). The following data relate to operation without X magnification (x10).*

## Analog mode:

Time base from 500ms/div to 50ns/div (without trace delay).

With trace delay, from 20ms/div to 50ns/div. Delay ranges from 20ms/div to 100ns/div.

Digital mode:

Time bases from 100s/div to 1µs/div.

This results in the following behavior when switched from analog to digital mode and vice versa:

1. If in analog mode, the time base has been selected between 500ns/div and 50ns/div, then on switching to digital mode the lowest available time coefficient will be automatically selected, i.e. 1µs/div. If now one switches back to analog mode without having made any time base changes in the digital mode, then the last time base selected in the analog mode is again active (e.g. 500ns/div).

If on the other hand, the time base is changed after switching over to digital mode (e.g. to 2µs/div). Then, when switched back to analog mode, the time base in analog mode will be set to the value selected in the digital mode (e.g. 2µs/div).

2. If a time base between 100s/div and 1s/div has been set in the digital mode and the mode is switched to analog, then the time base in analog mode is automatically set to 500ms/div. The rest is as described before.

The X-MAG x10 setting remains unchanged when switched from analog to digital mode and vice versa.

## Only in digital mode.

If by pressing **STOR. MODE - ON OFF** button long, the mode is switched to digital, then one of the associated LED's lights up. Which one it is, depends on the last selected digital operation. The digital operation will also be displayed in the Readout.

XY digital operation is an exception. In this case the LED RFR lights up and the Readout shows XY.

The possibilities of delayed trace and the related operations with delayed time base are not available in digital mode.

The desired signal capture mode in the Yt operation can be selected by briefly pressing the upper or lower **STOR. MODE** button.

- (7) **RFR** - stands for **refresh operation**. In this mode, as in analog mode, periodically repeating signals can be captured and displayed.

The signal acquisition is started by triggering a digital time base. Then the previously captured and displayed signal will be overwritten with the current signal. This will be displayed until the digital time base is triggered again. This is in contrast to analog operation where the screen remains blank when the time base is not triggered.

In **refresh mode**, the signal acquisition can be effected with pretriggering or post-triggering when a time base between 20ms/div and 1µs/div is selected.

The pretriggering or post-triggering will be automatically switched off (**PT0%**), with larger time coefficients (100s/div to 50ms/div) in order to avoid too long waiting times. If it is required to measure with pretrigger or post-trigger in this time base range, one should select single shot (SGL).

In **XY** digital mode the LED **RFR** lights. It indicates a continuous, trigger independent signal acquisition. The trigger circuit is switched off.

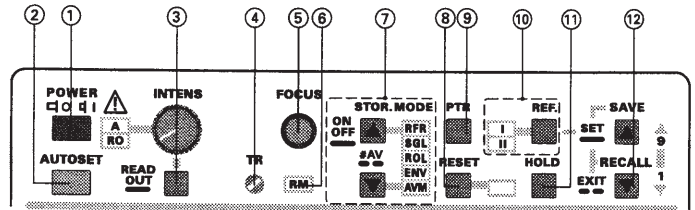

- (7) **SGL** - represents SINGLE SHOT. This is also displayed in the Readout.

In this operating mode a single signal acquisition process can be started with a trigger providing the trigger circuit has been activated with **RESET**. When switched over to **SGL**, single signal acquisition is in operation. The signal capture currently in progress and not yet finished will not be terminated but continued to the end. Besides, it will be **automatically** switched to **normal triggering** (NM LED lights up). Otherwise the trigger automatic will start signal acquisition processes without an input signal.

Thereafter, the **RESET** button (8) must be actuated so that the corresponding LED lights up. The signal acquisition will be effective at once if the HOLD function is not active. If the pretrigger function is active, the prehistory must elapse before the trigger event becomes effective. The signal capture terminates with the trigger event only with 100% pretrigger setting.

With all other pretrigger and post-trigger settings, the signal acquisition is not complete when the trigger occurs and will only be terminated later. Then the **RESET** LED extinguishes but the signal display remains. Actuating the **RESET** button again restarts a new single event capture which then overwrites the previously recorded display.

Single events recorded in DUAL mode can also be displayed in the XY mode when switched over to XY operation.

## Only in analog mode.

Capturing single events can also be carried out in analog mode (e.g. photographing)

The time base operation is switched on or off by briefly pressing the upper (**ON/OFF**) **STOR. MODE**-button (7).

Two signals can be displayed during a single sweep only when it is continuously switched between channel I and channel II (chopper operation). See DUAL (23).

If starting from an analog SINGLE shot operation, the component tester is switched on and then off again, the oscilloscope does not switch back automatically to analog SINGLE shot operation. This is also true for the digital mode.

(7) **ROL** - signals the **ROLL** mode. If the LED **ROL** is lit, then the Readout also displays **ROL**. In this case the signal is acquired continuously independent of any trigger. The latest signal sample acquired is displayed on the right hand edge of the scan. With each new sample the previous sample is shifted one address to the left. The sample displayed previously on the left edge of the scan is shifted out and lost. In contrast to refresh mode, the data acquisition in the ROLL mode is continuous without any trigger dependent waiting times (hold off time).

If a significant change in the signal occurs, the acquisition can be stopped and display frozen by the user with the **HOLD** button.

The time base range that can be used in the **ROLL** mode is limited. It extends from **100s/div** to **50ms/div**. Still lower time coefficients are not sensible, since it will not be possible to observe the signal.

In case one switches to the ROLL mode with the time base set to a value between 20ms/div and 1µs/div, it will be automatically reset to 50ms/div. The time base set previously before switching to ROLL mode will be internally stored (e.g. 20ms/div). The time base will be reset to this value when switched to ENV or SGL mode without changing the setting of TIME/DIV knob.

(7) **ENV** - is the abbreviation for **ENVELOPE** operation. In this mode the minimum and maximum values of the signal during several signal acquisition sweeps will be determined and displayed. Except for this display, the ENVELOPE operation is identical to the refresh operation.

Changes in the signal are easier to measure and are more visible in ENVELOPE operation. This is valid not only for amplitude changes but also for frequency variations (Jitter).

The **ENVELOPE** evaluation begins anew when the **RESET** button is actuated.

**Attention:**  
*The pretrigger or post-trigger will be automatically switched off (PT0%) in the time base range from 100s/div to 50ms/div.*

(7) **AVM** - indicates **AVERAGE** (mean value) mode. This operation is effective when the AVM LED lights up and the Readout displays **AV...**

In this case also several signal acquisition scans are required; hence, it is similar to Refresh operation. The signal is averaged over the several acquisitions so that amplitude variations (e.g. noise) and frequency variations (Jitter) are minimized or eliminated in the display. The basic mode AV4 is effective when the oscilloscope is switched on.

The accuracy of the mean value evaluation increases as the number of signal acquisition scans used for evaluation is increased. One can select the number between **2** and **512**. The selected setting is displayed in the Readout. Of course, with increasing accuracy the time required for this also increases.

To select a different value briefly press both **STOR. MODE** pushbuttons simultaneously. The AV... display in the Readout flashes indicating the setting mode. Now, the value can be

changed by briefly pressing the upper or lower **STOR. MODE** button. The setting mode can be exited by again briefly pressing the two buttons simultaneously. The setting mode will also be switched off automatically if none of the two buttons is actuated during about 10 seconds.

The averaging begins anew when the **RESET** button is actuated.

**Attention:**  
*The pretrigger or post-trigger will be automatically switched off (PT0%) in the time base range from 100s/div to 50ms/div.*

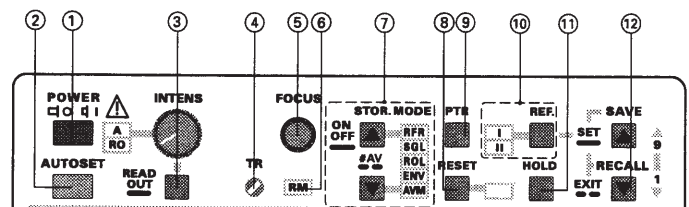

(8) **RESET** - pushbutton with related LED. The LED **RESET** lights up if „single shot“ is on (**SGL** LED is lit) and the **RESET** button is actuated. This starts a continuous signal acquisition providing the **HOLD** function is switched off. See also **SGL** (7).

**Attention:**  
*In the time base range from 100s/div to 50ms/div, the signal acquisition will be visible at once. This is displayed as in ROLL mode, but has otherwise nothing to do with ROLL mode.*

Trigger events only cause a triggering after the time for the prehistory has elapsed, otherwise it will result in an erroneous signal display.

The **RESET** LED is switched off at the end of a recording following a triggering.

In case of **ENVELOPE** (**ENV**) or **AVERAGE** (**AVM**) operation, the enveloping or averaging respectively begins anew when the **RESET** button is actuated.

(9) **PTR** - pushbutton for the selection of prehistory (pretrigger) or post-history (post-trigger) referred to the trigger event.

The current pretrigger or post-trigger setting will be displayed by the Readout and changes in the following sequence each time the button is pressed:

**PT0% - PT25% - PT50% - PT75% - PT100% - PT-75% - PT-50% - PT-25% - and again PT0%.**

The percentage values of the pretrigger and post-trigger are related to the graticule scale (X direction) of the CRT. Because this function is dependent on a trigger event, this is not available in the trigger independent signal acquisition modes **ROLL** and **XY**.

The following description assumes that the X expansion (**X-MAG. x10**) is switched off and that the trace begins at the left edge of the graticule. Further it is assumed that a trigger mode (source, coupling) has been selected in which the trigger point is indicated by a symbol. In digital mode, the term trigger point includes trigger level and the trigger time referred to the graticule.

**Pretriggering.**

0% pretriggering (Readout: **PT0%**) means that the display begins with trigger event at the left edge of the scale. Hence the trigger point symbol appears there. If in addition, an arrow pointing left appears, it indicates that the trigger point is to the left of the left edge (e.g. because of X position shift).

25% pretriggering (Readout: **PT25%**) is selected by pressing the PTR button once from 0%. Then 25% of prehistory is displayed in the first 2.5 cm. Correspondingly the trigger point symbol appears 2.5cm from left.

The pretrigger and the acquired prehistory increases by 25% each time the PTR button is pressed until the pretrigger value reaches 100%. The Readout and the trigger point symbol show the setting. If in addition, an arrow pointing right appears, it indicates that the trigger point is to the right of the right edge (e.g. because of X position shift).

The duration of the prehistory is arrived at by multiplying the time base by the pretrigger value in centimeters (divisions). E.g. 20ms/div x 7,5 (75% pretrigger) = 150ms.

**Post-triggering.**

In case of post-triggering the trigger point is always to the left of the left edge of scale and this is signaled by a left arrow. The trigger point cannot be made visible by shifting the X position control. The display shows only the trigger level for all post-trigger conditions. Post-trigger condition is therefore denoted by a minus sign (-) in front of the percent value (e.g. **PT -50%**).

If the PTR button is pressed once starting from 100% pretriggering, then the Readout shows PT -75%. Now the signal acquisition begins with post-triggering. The trigger point is 75% (7.5 cm) before (to the left of) the left edge of scale. The signal acquisition will be started after a corresponding time delay after the trigger event.

Each further actuation of the button switches to PT-50% and to PT-25% and back to PT0%.

Pretriggering and post-triggering will be automatically switched off (**PT-0%**), when the time base is set to a value between **100s/div** and **50ms/div** in REFRESH (**RFR**), ENVELOPE (**ENV**) and AVERAGE (**AVM**) modes.

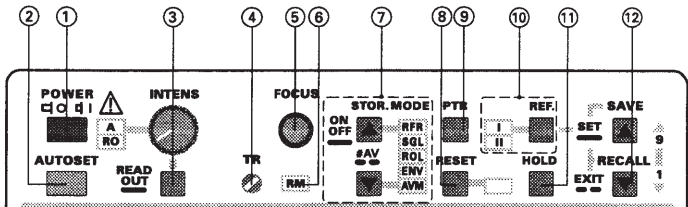

(10) **REF.** - pushbutton associated with 2 LED's (only in Yt (time base) storage mode).

The oscilloscope contains 2 non volatile reference memories. A reference signal can be displayed together with the actual signal. The contents of the reference memory are not erased when the instrument is switched off. No reference signal is displayed with the actual signal when neither of the LED's marked **I** or **II** is lit. When only channel I is in use, briefly pressing the REF button switches on LED I and the reference signal 1 is displayed in addition to the current signal in channel 1. The renewed actuation of the button switches the reference signal and the **REF. I** LED off. The operation is similar when only channel II is in operation. The button switches the **REF. II** LED and the display of reference II signal on or off. It is possible to select between REF. I and II only in DUAL mode. Each time the REF button is pressed the next in sequence is selected. The switching sequence is: all REF. LED's off, REF. I lights up, REF. II lights up and all REF. LED's off. The LED lit indicates the display of the corresponding reference memory contents. The display of the current signal is not influenced by the display of the reference signal.

The procedure below should be followed to overwrite the reference memory contents with the current signal:

First of all select the memory desired by briefly pressing the **REF** button. Then press and hold the REF button until an acoustic signal sounds. This confirms the acquisition of signal data in the reference memory. Before taking over the current signal in the memory one may (not a must) switch to HOLD.

**Attention!**  
*As the reference signal is in the same position (superimposed) as the current signal it is not immediately noticeable in most cases.*

(11) **HOLD** - Pushbutton to protect the current memory contents.

Each time the button is pressed the instrument switches over between protected and unprotected mode of the current memory contents.

The current contents of the memory are protected against overwriting when **HLD** (HOLD) instead of channel information (e.g. CH1) is displayed in the Readout.

The buttons for switching the Y-operating mode CH I (22), CH II (26) and DUAL (23) are disabled. It will be possible to switch between Yt-DUAL and XY display by pushing the button longer, only if DUAL or XY mode was selected before switching to HOLD.

One can observe how the existing memory contents are successively overwritten by new data especially with slow time base settings and refresh mode. Protecting the memory contents in the middle of a data acquisition process can result in an irregularity at the junction of old (right) and new data (left). This can be avoided by recording in single shot mode (SGL), even though the input signal is repetitive. At the end of a sweep, one can use HOLD to protect the contents against being overwritten by an unintentional actuation of RESET.

The signal in each of the current memory can be shifted in the vertical direction (+/- 4cm) with the corresponding Y-POS rotary knob when HOLD is operative. Providing , of course, the Y-POS control is not switched to CURSOR setting.

The original trace position will be lost when shifted vertically, but this can be found again. To this end the Y-POS knob in question must be rotated quickly. Once the original position is reached, the trace does not shift anymore although the knob is rotated further. Simultaneously a signal tone sounds. To shift the trace vertically again it will be required to stop rotating the knob for at least about 2 seconds.

**Attention:**  
*The dynamic range limits of the A/D converter may become visible if a Y-position shift is performed after storage. This can affect those signal parts which were originally beyond the vertical graticule limits.*

**(12) SAVE / RECALL** - pushbutton for saving the instrument settings and menu selection.

The oscilloscope contains 9 memories for this purpose. All electronically selected settings are stored here and can be recalled.

Press the **SAVE** button briefly once to start the save procedure. At the top right of the Readout appears a S for SAVE (= store) and a storage location number between 1 and 9. The storage location can be selected with the buttons SAVE- and RECALL. Each time SAVE (arrow shows upwards) is briefly pressed, the location number will be increased by 1 until it reaches „End position“ 9. Similarly each time RECALL (arrow shows downwards) is briefly pressed, the location number will be decreased by 1 until it reaches „End position“ 1. The current settings can now be stored in the location number shown by pressing SAVE longer.

To recall a previously stored setting, press **RECALL** button briefly once and then select the store location. If now the RECALL button is pressed longer, the previously stored control settings will be taken over by the oscilloscope.

**Attention:**  
*Make sure that the signal to be displayed is identical to the one that was present when the settings were stored. If the signal is different (frequency, amplitude) to the one during storage then a distorted display may result.*

If the SAVE or RECALL function was inadvertently called, then pressing both buttons at the same time switches the function off. Or, one can wait. The function will also be automatically switched off after approximately 10 seconds.

**Menu function!**

The buttons (SAVE and RECALL) are also used for menu selection. For further information relating to this see section Menu.

**The controls and indicators related to the Y- amplifiers, mode selection, trigger and time base are located beneath the front panel sector previously described.**

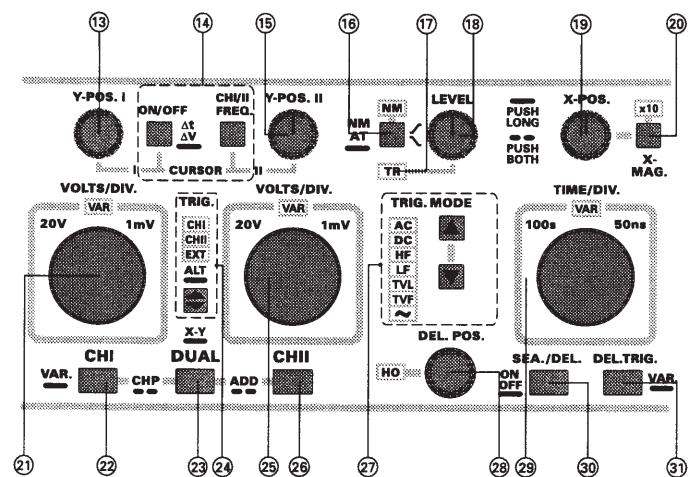

**(13) Y-POS. I** - rotary switch with two functions.

The vertical position of the channel I trace is set with this knob when CURSOR lines are switched off. In the Add operating mode both the controls (Y-POS. I and II) will shift the trace.

The Y-POS. I rotary knob can be also used for setting one of the CURSOR lines when it is displayed. Of course, in this case it does not operate as Y-Position control for trace. See article (14).

**Only in digital mode.**

If the Y-POS. I knob is not acting as CURSOR control, then it can be used for shifting the vertical position of a signal stored with HOLD. Additional information relating to this operation are described under (11) HOLD.

**(14) ON/OFF-ΔV/Δt - CHI/II-FREQ.** - buttons

Briefly pressing the buttons ON/OFF-ΔV/Δt switches the CURSOR on or off. If the Readout is switched on, then two cursor lines appear on the display, providing the CURSOR function is switched on. In this case the knobs Y-POS. I (13) and II (15) do not control the vertical position of the signal trace, but the position of the CURSOR lines marked I and II respectively.

When the cursors are switched on, one can switch between voltage and time/frequency measurement by pressing the buttons ON/OFF-ΔV/Δt relatively long.

**Voltage measurement in DUAL.**

The cursors are displayed in the Readout as horizontal lines for voltage measurement. It will be required to select between the deflection coefficients (sensitivity) of channel I and II, which may be different, only in the DUAL operation.

Briefly pressing the CHI/II-FREQ. Button switches between channel I and II and vice versa. The measured result is displayed at the top right of the Readout with ΔV1:... or ΔV2:... providing the deflection coefficient is calibrated. The settings of the cursors must relate to the signal of the selected channel. The measured voltage value refers to the signal at the oscilloscope input without taking into account any attenuation probe.



When measured with an attenuation probe, the displayed value should be multiplied by the attenuation ratio of the probe.

## Voltage measurement with ADD.

The two channels should be operated with the same sensitivity in addition mode (ADD). Therefore, for voltage measurement it cannot and need not be selected between CH I and II (button CH I/II-Freq. is disabled). The Readout shows  $\Delta V$ .... If, however, the sensitivities are different ( e.g. one channel is uncalibrated ) then the Readout shows  $Y1 <> Y2$ .

## Voltage measurement in XY.

In the XY and  $\Delta V$  (voltage measurement) modes, the cursors will transform from horizontal lines (Readout  $\Delta VY$ :...) to vertical lines when switched from CH I to CH II. The Readout then shows  $\Delta VX$ :....

No exact results can be shown when measured with uncalibrated deflection coefficients (Readout at bottom shows e.g. CH1>...). The Readout shows  $\Delta V1 > \dots$  or  $\Delta V2 > \dots$ ,  $Y1 <> Y2$  in case of Addition operation (ADD), or  $\Delta VY > \dots$  or  $\Delta VX > \dots$  in XY operation.

## Time /frequency measurement.

Pressing the ON/OFF- $\Delta V/\Delta t$  button relatively long, switches the operation from voltage measurement to time /frequency measurement and the CURSOR lines from horizontal to vertical. The Readout at top right indicates either  $\Delta t$ ..., or  $f$ .... The CURSOR lines can be displaced horizontally with the knobs Y-POS. I and II.

One can switch from time to frequency measurement with the button CH I/II-FREQ. during  $\Delta t$  measurement mode. The time measured will be shown as  $\Delta t$ :... in Readout if the time base is calibrated. With frequency measurement the indication is  $f$ :.... When the time base is uncalibrated the display shows  $\Delta t > \dots$  or  $f < \dots$ .

**Attention:**  
Time and frequency measurements are not possible in XY operation, since in this mode the time base is switched off.

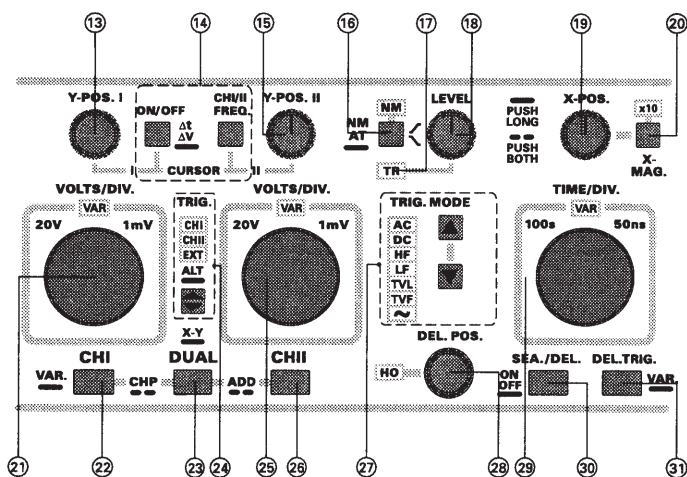

(15) Y-POS. II - Rotary knob with two functions.

The **vertical** position of the **channel II trace** is defined by this knob when the CURSOR lines are switched off. The position will be determined by both the knobs Y-POS. I and II in case of addition operation.

The Y-POS. II rotary knob can be also used for setting one of the CURSOR lines when it is displayed. Of course, in this case it does not operate as Y-Position control for trace. See article (14).

## Only in digital mode.

If the Y-POS. II knob is not acting as CURSOR control, then it can be used for shifting the vertical position of a signal stored with HOLD . Additional information relating to this operation are described under (11) HOLD.

(16) **NM / AT** - The **NM** (Normal Triggering) LED is located above this button which has a double function. It is lit when one switches from AT (automatic, peak value triggering) to normal triggering, by pressing the button long. Pressing the button long again switches back to automatic (peak value) and the **NM** LED goes off.

The **second function** is related to the **trigger slope selection**. The slope which will be used to trigger will be switched from rising to falling edge and vice versa each time the button is briefly pressed. The selected setting will be indicated in the Readout as rising or falling slope.

In case of **automatic triggering**, the **peak value detection** (triggering) will be switched on or off depending on the mode and the selected trigger coupling. The state is indicated as follows by the behavior of the trigger level symbol when the LEVEL knob is rotated.

1. The peak value detection is active if a horizontally undeflected trace is displayed and the trigger level symbol practically does not shift with changes in the LEVEL rotary knob.
2. The peak value detection is also active if the trigger level symbol can be shifted only within the limits of the signal amplitude, with the LEVEL rotary knob.
3. The peak value detection is switched off, if an untriggered display results when the trigger level symbol is shifted outside the signal amplitude limits.

(17) **TR** - When the time base receives trigger signals this LED lights up. Whether the LED flashes or is continuously lit depends on the frequency of the trigger signal.

The TR-LED does not light up in Analog and Digital XY modes.

(18) **LEVEL** - The trigger point is set with the rotary knob **LEVEL**. This trigger point is the voltage level which must be exceeded or below which the signal must fall ( depending on the selected trigger slope) in order to start a time base scan. The trigger point is indicated with the Readout by a symbol at the left graticule edge in most Yt operating modes. This symbol is blanked out in those modes where there is no direct relation between the trigger signal and the trigger point.

The position of the trigger point symbol shifts in the Readout when the LEVEL setting is changed. The shift is in the vertical direction and is related of course to the start of the signal trace. The symbol is replaced by an arrow in order to give an indication of the position of the trigger point when it is outside the graticule limits, as well as to avoid overwriting other readout information.

**Only in digital mode.**

The horizontal position of the trigger point symbol is the same in analog and digital modes only when 0% pretrigger is selected. See PTR-button (9).

**(19) X-POS.** - This rotary knob shifts the display in the horizontal direction and thus enables, especially in the X x10 magnified operation, any part of the signal to be displayed on the screen. It is also operative in the analog XY mode.

**Only in digital mode.**

In XY operation the knob is disabled. An X Position shift can be carried out with the knob Y-POS. II (15).

**(20) X-MAG. x10** - Each time the button is pushed the x10 LED is switched on or off. The display is expanded ten fold in the X direction when the LED is lit. The time base indication in the Readout also changes accordingly. To observe a section of the display with expansion, one can align the center of the section to be observed with the center vertical line of the graticule, with the X-POS control, before switching on the expansion.

In XY operation the button X-MAG. is inoperative.

**Only in analog mode.**

The fastest unexpanded time base is 50ns/div. If this time base has been selected, then switching on the X magnification (X-MAG. X10) expands the display only 5 times (10ns/div).

**(21) VOLTS/DIV.** - A rotary knob is provided for channel I (CHI) in the VOLTS/DIV Field. This knob has a double function.

The rotary knob is only operative when the channel I is active and its input is switched on (AC or DC input coupling). Channel I is operative in the modes CH I (Mono), DUAL, ADD (Addition) and XY. The second function as fine adjustment is described under VAR (22).

The following description is based on the function: Setting deflection coefficient (Attenuator switch). This is valid when the VAR LED is not lit.

Rotating the knob anticlockwise decreases the sensitivity (deflection coefficient is increased), and rotating it clockwise increases the sensitivity (deflection coefficient is reduced). The sensitivity can be set from 1mV/div. to 20V/div. in 1-2-5 sequence.

The deflection coefficient is indicated in the Readout (e.g. CH1:5mV...). A " >" Symbol will be shown instead of ":" in the uncalibrated operation.

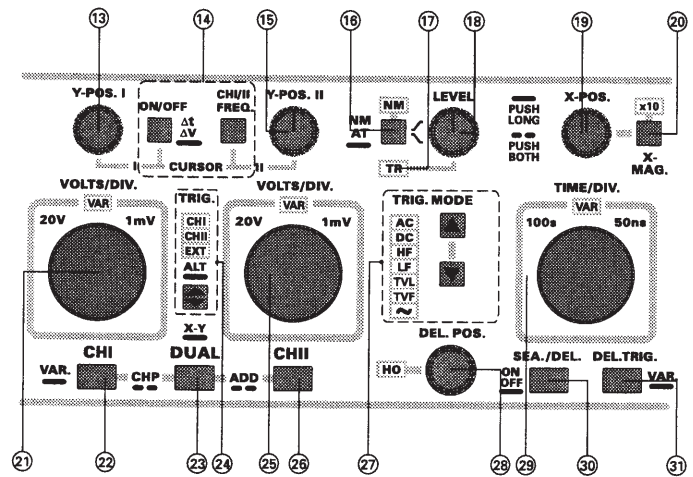

**(22) CH I - VAR.** push button has several functions.

Briefly pressing the button switches the oscilloscope to channel I (single channel mode). The internal trigger source will be automatically switched to Channel I, if before neither external nor mains (power line) triggering was active. The Readout shows the deflection coefficient of the channel I (CH1...) and the TRIG. CHI LED lights up. The last selected function setting of the VOLTS/DIV. knob (21) is effective.

All controls related to this channel are active providing the input (32) is not set to ground GD(34).

The function of the knob VOLTS/DIV. is switched over each time the button CH I is pressed long, and the current function is indicated by the VAR LED above it. The sensitivity of channel I can be set in calibrated steps (1-2-5 sequence) with the knob when the VAR LED is off. If now CH I button is pressed long, the VAR LED lights up and indicates that the knob is working as a fine setting control. The calibrated sensitivity remains unchanged until the knob is rotated a raster step anticlockwise. The display amplitude is reduced and becomes uncalibrated ("CH1>..."). The sensitivity is further reduced as the knob is rotated anticlockwise. An acoustic signal sounds when the lower end of the fine adjustment range is reached.

As the knob is rotated clockwise, the sensitivity increases (deflection coefficient is reduced) and the displayed amplitude increases until the upper setting limit is reached which is again signaled by an acoustic signal. The display then becomes calibrated (CH1:...).

The function of the knob can be switched to the attenuator function (1-2-5 sequence, calibrated) again at any time, independent of the setting of the fine adjustment, by pressing the CHI button long. The VAR LED is switched off and the "CH1>..." display will be replaced by "CH1:...".

As the front panel markings intimate the CH I button (22) can also be operated with the operation of the DUAL button (23). See article (23).

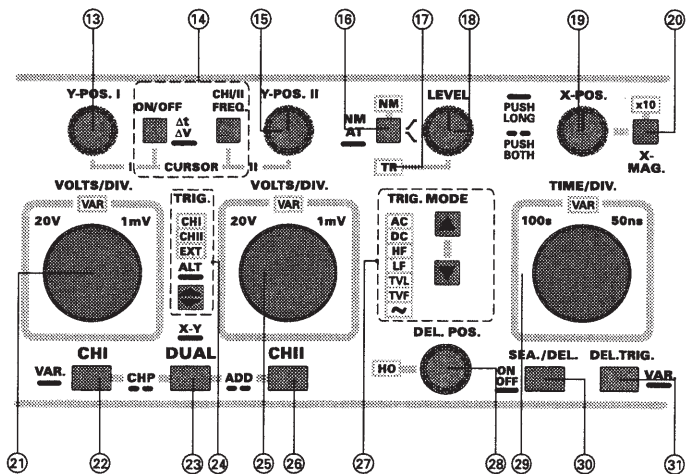

(23) DUAL - XY pushbutton with several functions.

**DUAL** operation is selected by briefly pressing DUAL button. The deflection coefficients of both channels will now be displayed in the Readout if single channel was in operation previously. The trigger conditions (trigger source: TR:...) last set remain unchanged but can be altered. All controls relating to Y deflection are operative only when none of the inputs is grounded ( set to GD ).

All channel related controls are enabled providing no input is set to GD (34) (38).

The **Readout** shows (only in analog mode; right of the deflection coefficients) with **ALT** (alternate) or **CHP** (Chopper) how the channel switching is performed. This is dependent on the selected time base in the analog mode.

**Chopper (CHP)** display is automatically carried out in the time base range from 500ms/div. To 500µs/div. In this operation the display is repeatedly switched between channel I and II during a sweep.

**Alternate** switching (**ALT**) is performed automatically in the time base range from 200µs/div. to 50ns/div. In this mode one channel is displayed during a sweep and the other channel during the next sweep and so on alternately.

The channel switching mode defined by the time base can be changed. This is carried out in DUAL mode by simultaneously pressing DUAL (23) and CH I (22) buttons. If thereafter, the time base (TIME/DIV. knob) setting is changed then the channel switching is again defined by the time base.

**Only in digital mode.**

The signal acquisition is carried out with both A/D converters in the two channel (DUAL) digital mode. Since there is no need to switch channels as in analog mode, the Readout display shows digital mode instead of ALT or CHP.

In the DUAL mode, **ADD** (Addition) operation is selected by simultaneously pressing DUAL (23) and CH II (26) buttons. The trigger level symbol is switched off in this mode. The addition mode is indicated in the Readout by the addition symbol + between the deflection coefficients of the two channels.

The two signals are added or subtracted (algebraic sum or difference) in ADD (Addition) mode, and the result is displayed as a single signal. The result is only then correct when the two sensitivities are identical.

The time axis (Y position) of the signal can be influenced by both the Y POS. knobs.

**XY operation** can be switched on or off by pressing the DUAL button longer. The deflection coefficient in the Readout then shows "VY: ..." for channel I, "VX: ..." for channel II and "XY" for the mode. The controls related to time base and trigger are disabled in the analog XY operation.

The inverter for channel II (INV. (38)) and the Y-POS. II (15) are also disabled. The display can be displaced in the X direction with the control X-POS. (19).

**Only in digital mode.**

**XY Digital mode** is indicated by the RFR LED (7) which lights up, in addition to the display "XY" in the Readout. Then, other STOR. MODE settings cannot be selected. The Readout also shows the sampling rate (e.g. 40MS/s), which can be set with the TIME/DIV. knob (29).

There are gaps in the display of Lissajous figures when the sampling rate is too high. A too low sampling rate can result in a display which does not permit the frequency ratio of the two signals to be determined. The selection of a suitable sampling rate is simplified if both the signals are first displayed in the refresh DUAL mode. The TIME/DIV control should be then so set that at least one period of each signal is displayed. After this one can switch to the XY Digital mode.

**Attention!**  
**Note the following differences compared to the analog XY mode: Channel II can be inverted (INV. (Invert) button (38)). The Y POS. II control (15) functions as X-Position control; The X-POS control (19) is disabled.**

(24) TRIG. - pushbutton with the related LED's.

The trigger source selected with this button is indicated by the related LED's (**CHI**, **CHII** and **EXT**). A precondition is that an operating mode has been selected in which the trigger is enabled. Thus, in XY or ROLL mode there is no indication of trigger source. The TRIG. button is disabled and none of the TRIG. LED's light up with mains (line) triggering.

The term trigger source defines the source signal which is used for triggering. If a signal is applied to the TRIG. EXT. socket (39), it can be used as a trigger source. In this case the triggering is external. The EXT LED lights up and the trigger level symbol is switched off.

It is also possible to trigger internally. The trigger signal is then derived from channel I or II, and the corresponding LED (**TRIG. CHI** or **CHII**) is lit.

The internal trigger source which can be selected depends on the channel mode; the external triggering is independent of this.

In single channel mode, one can select between the currently used channel and the external trigger input (TRIG.EXT. socket) by briefly pressing the button each time. In the single channel mode, the trigger source will also be switched automatically on switching from channel I to channel II and vice versa if internal triggering is used.

In **DUAL** and **ADD** (Addition) modes, the trigger source will be switched over in the **sequence CHI, CHII, EXT, CHI ....**, each time the button is briefly pressed.

Pressing the button longer switches to the (internal) alternate triggering. Since **alternate trigger** assumes **alternate DUAL mode**, this mode will also be automatically selected. Then the LED's **TRIG. CHI** and **CHII** are simultaneously lit. In this mode, the trigger source is switched (CHI, CHII) synchronously with channel switching. The trigger level symbol is not shown in alternate mode. The alternate triggering can be switched off by briefly pressing the button.

It is not possible to select alternate triggering in ADD (Addition) mode.

**Only in digital mode.**

The pretriggering or post-triggering will be automatically switched off (set to 0% = PT0%) when alternate trigger mode is selected.

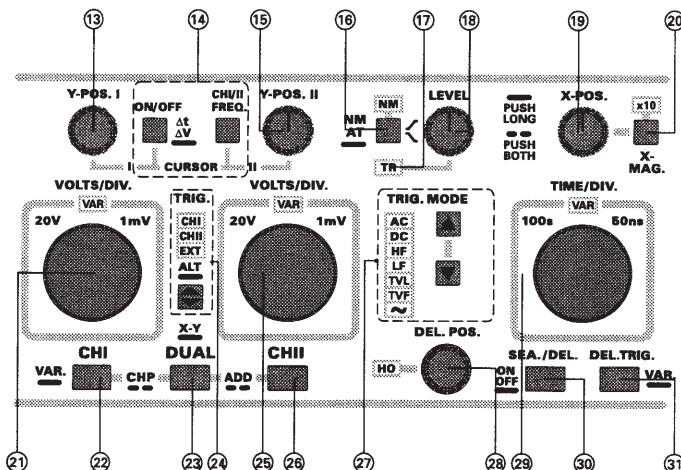

**(25) VOLTS/DIV.** - A rotary knob is provided for channel II (CHII) in the **VOLTS/DIV** field. This knob has a double function.

The rotary knob is only operative when the channel I is active and its input is switched on (AC or DC input coupling). Channel I is operative in the modes **CH II** (Mono), **DUAL**, **ADD** (Addition) and **XY**. The second function as fine adjustment is described under **VAR** (26).

The following description is based on the function: Setting deflection coefficient (Attenuator switch). This is valid when the **VAR** LED is not lit..

Rotating the knob anticlockwise decreases the sensitivity (deflection coefficient is increased), and rotating it clockwise increases the sensitivity (deflection coefficient is reduced). The sensitivity can be set from 1mV/div. to 20V/div. in 1-2-5 sequence.

The deflection coefficient is indicated in the Readout (e.g. **CH2:5mV...**). A ">" Symbol will be shown instead of ":" in the uncalibrated operation.

**(26) CH II - VAR.** push button has several functions.

Briefly pressing the button switches the oscilloscope to channel II (single channel mode ). The internal trigger source will be automatically switched to Channel II if before neither external nor mains (power line) triggering was active. The Readout shows the deflection coefficient of the channel II (**CH2...**) and the **TRIG. CHII** LED lights up. The last selected function setting of the **VOLTS/DIV.** knob (25) is effective.

All controls related to this channel are active providing the input (36) is not set to ground GD(38).

The function of the knob **VOLTS/DIV.** is switched over each time the button **CH II** is pressed long, and the current function is indicated by the **VAR** LED above it. The sensitivity of channel II can be set in calibrated steps (1-2-5 sequence) with the knob when the **VAR** LED is off. If now **CH II** button is pressed long, the **VAR** LED lights up and indicates that the knob is working as a fine setting control. The calibrated sensitivity remains unchanged until the knob is rotated a raster step anticlockwise. Then the display amplitude is reduced and becomes uncalibrated ("**CH2>...**"). The sensitivity is further reduced as the knob is rotated anticlockwise. An acoustic signal sounds when the lower end of the fine adjustment range is reached.

As the knob is rotated clockwise the sensitivity increases (deflection coefficient is reduced) and the displayed amplitude increases until the upper setting limit is reached which is again signaled by an acoustic signal. The display then becomes calibrated (**CH2:...**).

The function of the knob can be switched to the attenuator function (1-2-5 sequence , calibrated) again at any time, independent of the setting of the fine adjustment, by pressing the **CHI** button long. The **VAR** LED is switched off and the "**CH2>...**" display will be replaced by "**CH2:...**".

As the front panel markings intimate the **CH II** button can also be operated with the operation of the **DUAL** button (23) (**ADD** = Addition mode). See article (23).

**(27) TRIG. MODE** - Pushbutton with related LED's.

Pressing one of the two **TRIG. MODE** buttons selects the trigger coupling (coupling of the trigger signal to the trigger circuits). The selected coupling is indicated by a LED. Starting from AC trigger coupling, the trigger coupling changes in the following sequence each time the lower **TRIG** button is pressed:

- AC** - Alternating voltage coupling (DC content suppressed)
- DC** - Direct current coupling (with automatic triggering, peak value detection is inactive)
- HF** - High frequency coupling with filtering out of low frequency contents (no trigger level symbol)
- LF** - Low frequency coupling, suppression of high frequency components. (During automatic peak value triggering , the trigger signal is coupled to the trigger comparator through a capacitor (AC); During normal triggering with DC coupling.)

- TVL** - TV-Trigging with line synchronizing pulse (no trigger level symbol)
- TVF** - TV-Trigging with frame synchronizing pulse (no trigger level symbol)
- ~ - Mains (line) frequency triggering (no trigger level symbol)

Some trigger coupling modes are disabled and therefore cannot be selected in some operating modes, e.g. alternate triggering.

The **TRIG.** button (24) is disabled and no **TRIG.** LED (24) lights up with **mains (line)** frequency triggering.

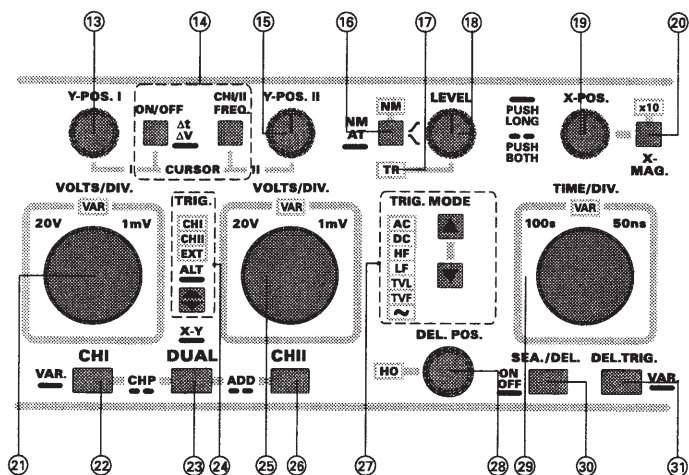

- (28) DEL. POS.** - rotary knob with two functions and related **HO LED**.

**The following description is with reference to analog mode only.**

The **DEL.POS.** rotary knob functions as a Hold off time control, when the time base is not working in the **SEA.** (SEARCH) or in **DEL.** (DELAY) mode. The **HO**-LED is not lit when the hold off time is set to minimum. The **HO LED** lights up and the hold off time increases as the knob is rotated clockwise. A signal sounds on reaching the maximum hold off time. Similarly in the opposite direction until minimum hold off time is reached (**HO LED** extinguishes). The hold off time is automatically set to minimum when the time base is changed. (For the application of hold off time setting see the paragraph with the same heading).

The start of the trace can be set with the **DEL.POS.** control in the time base modes **SEA.** (SEARCH) or **DEL.** (DELAY). See **SEA./DEL.-ON/OFF** (30).

**Only in digital mode.**

The **DEL.POS.** control **and** the **HO LED** are **disabled**, since in this mode the hold off time is set to minimum. The hold off time last used in the analog mode is not saved. Consequently, the hold off time is set to minimum when it is switched back to analog mode.

The **DEL.POS.** control cannot be used for delay setting since neither **SEA.** (SEARCH) nor **DEL.** (DELAY) time base operation is available.

- (29) TIME/DIV.** - The time base is set with this rotary knob in the **TIME/DIV.** field, and the setting is displayed at the top left in the Readout (e.g. "**T:10µs**"). This knob acts as the time base step switch when the **VAR LED** above it is not lit. Then, the time deflection coefficient can be set in a 1-2-5 sequence and the time base is calibrated. Rotating anticlockwise increases the deflection coefficient and rotating clockwise decreases the deflection. The control acts as a vernier (fine adjustment) when the **VAR LED** is lit. The following description refers to the function as a time base switch.

Time deflection coefficients between 500ms/div. and 50ns/div. in a 1-2-5 sequence can be selected in the analog mode without x10 X magnification. Time delay between 100ms and 100ns can be selected in the "SEA" (SEARCH) mode.

Time deflection coefficient range in the "DEL" (DELAY) mode extends from 20ms/div. to 50ns/div.

The time base can be set to deflection coefficients between 100s/div. and 1µs/div in digital mode.

**Attention:**  
**The different deflection coefficient ranges between the analog and digital time bases require special consideration when switching between analog and digital modes. These are described in article (7).**

- (30) SEA./DEL. - ON/OFF** pushbutton.

**Only in analog mode.**

This button is used to switch between delayed and undelayed time base. The delayed time base operation enables a magnified display in X direction which is otherwise only possible with a second time base.

Pressing the button longer switches to **SEA.** (SEARCH) mode, when currently neither "SEA" (SEARCH) nor "DEL" (DELAY) operation is effective. Afterwards, it can be switched between **SEA.** and **DEL.** by briefly pressing the button.

These operating modes are indicated in the Readout at the right of the trigger slope indication thus:

In case of **SEARCH**, "**SEA**" will be displayed; In **untrigged DELAY** mode, "**DEL**" (DEL.) and in **trigged DELAY** mode, "**DTR**" (DEL.TRIG.).

None of these will appear in the Readout in undelayed time base operation.

When "SEA" or "DEL" or "DTR" mode is effective, pressing the button long switches over to undelayed time base.

The following description assumes that, with x10 X-MAG. switched off, the trace starts at left edge of the graticule and a time base has been selected which will enable an eventually expanded section to be visible.

In **SEA.** (SEARCH) mode, the hold off time is automatically set to minimum and a part of the display (starting at the left edge) will not be visible. Subsequently the trace will be brightened (visible) until it reaches the right edge. The position of the start of the visible trace can be varied

with DEL.POS (fine adjustment) from about 1 to 7 divisions. The blanked out range serves as an indication of the delay time which is being „searched „ for here. The delay time is based on the current time deflection coefficient setting and can also be coarsely set with the TIME/DIV control (range: 20ms to 100ns).

Pressing the button briefly switches over from "SEA" to "DEL" (DELAY) mode. Now the display begins at the left edge without any blanked out section. The start of the section, which was previously brightened in the "SEA" (SEARCH) mode, now lies at the left edge. The display can be expanded in the X direction by rotating the TIME/DIV control clockwise and thus decreasing the time deflection coefficient. If a part of the signal of interest goes beyond the right edge, it can be brought within the screen and made visible by DEL. POS. knob. Increasing the time deflection coefficient beyond that used in the "SEA" (SEARCH) mode is not provided as it is practically meaningless.

In the untriggered "DEL" (DELAY) mode, a trigger event does not start the trace at once but only starts the delay time. The sweep is started only at the expiration of the delay time.

In triggered DELAY mode (DTR), to start the sweep, a signal suitable for triggering must appear after the delay time. The sweep will be started if the instrument settings (e.g.. LEVEL setting) enable a triggering. See DEL.TRIG. (31).

**(31) DEL.TRIG. - VAR. -pushbuton with two functions.**

**Only in analog mode.**

In the case of untriggered "DEL" (DELAY) mode, briefly pushing the button switches over to "DTR" (triggered DELAY mode). Thereby, the previously active settings, Automatic/normal triggering (16), Trigger LEVEL (18), Trigger slope (16) and trigger coupling (27) will be saved. It will be automatically switched to normal triggering and DC trigger coupling in "DTR" mode. Subsequently the trigger LEVEL setting and the trigger slope should be so adjusted that the signal for delayed trigger can trigger the trace. Without triggering the screen will remain blank.

Briefly pressing the button again switches back to DEL. Operation.

**Only in analog mode.**

Pressing the button longer changes the function of the TIME/DIV. knob.

The TIME/DIV. Rotary knob can function as a time deflection coefficient switch or as a time vernier (fine adjustment). The current function is indicated by the VAR LED. The rotary knob functions as a vernier when the VAR LED is lit, whereby the time base is at first calibrated. The time base becomes uncalibrated when the knob is rotated one step anticlockwise. The Readout now shows "T>..." instead of "T:..." . Rotating further anticlockwise increases the time deflection coefficient (uncalibrated) until the maximum which is acoustically signaled. Rotating the knob clockwise decreases the time deflection coefficient until the acoustic signal sounds. Now, the vernier is again in the calibrated position and the symbol " >" will be replaced by symbol " :".

The function of the knob can be switched back to calibrated time base switching function at any time, independent of the setting in the vernier mode, by pressing the VAR. button longer. The VAR-LED. extinguishes.

**BNC sockets, four pushbuttons, as well as a 4 mm socket for a Banana plug are located at the bottom most field of the large front panel.**

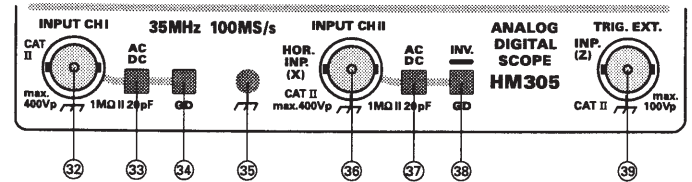

**(32) INPUT CH I** - BNC socket serves for the signal input of channel 1. The outer connector of the socket is galvanically connected to the earth wire (protective earth) of the mains (line ). In the XY operation this input is connected to the Y amplifier. The following pushbuttons are associated with the input:

**(33) AC**

**DC** - The signal input (32) is switched between AC- (alternate current) and DC- (direct current) coupling each time the button is pushed. The actual setting is indicated in the Readout behind the deflection coefficient with the symbols " ~" and "= " respectively.

**(34) GD**

- If the **earth symbol** is indicated in the Readout in place of the deflection coefficient and signal coupling, then the signal at the input is switched off and (in the case of automatic triggering) only a trace undeflected in the vertical direction (reference for ground potential) will be displayed.

The value of an applied DC voltage can be determined with reference to the above mentioned Y-position of the trace when DC coupling is selected (input enabled).

**(35) Ground socket** - for a Banana plug with a diameter of 4 mm. The socket is galvanically connected to the mains (line) earth conductor.

The socket can be used as reference potential when measuring DC or low frequency AC signals.

**(36) INPUT CH II** - BNC-socket serves for the signal input of channel II. The outer connector of the socket is galvanically connected to the earth wire (protective earth) of the mains (line ). In the XY operation this input is connected to the X amplifier. The following pushbuttons are associated with the input BNC socket.

**(37) AC**

**DC** - Each time the button is pushed the signal input (36) is switched between AC- (alternate current) and DC- (direct current) coupling. The actual setting is indicated in the Readout behind the deflection coefficient with the symbols " ~" and "= " respectively.

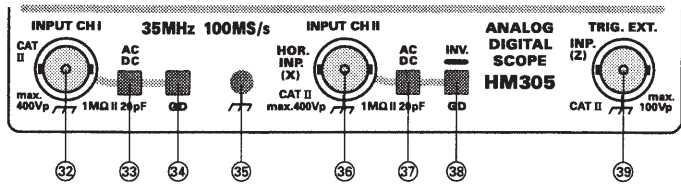

(38) **GD - INV.** - pushbutton with two functions.

The input (**INPUT CH II (36)**) is switched over from on to off or off to on each time the button is pushed briefly.

If the earth symbol is indicated in the Readout in place of the deflection coefficient and signal coupling, then the signal at the input is switched off and (in the case of automatic triggering) only a trace undeflected in the vertical direction (reference for ground potential) will be displayed.

The value of an applied DC voltage can be determined with reference to the above mentioned Y-position of the trace when DC coupling is selected (input enabled).

**INV:**

The display is switched over from direct to inverted display and vice versa each time this button is pressed longer. The Readout displays a horizontal bar above channel data (CH2) when inverted. The channel II signal is displayed rotated by 180° (not in XY mode). The button must be pressed long again to exit this condition. The display becomes uninverted as originally and the bar above the channel data is removed. This button has no effect when only channel I is in operation.

**Only in digital mode.**

In contrast to XY analog operation, the X Signal can be inverted in XY Digital mode.

(39) **TRIG. EXT.** - BNC socket serves for the external trigger input signal. The coupling of the trigger signal is determined by the pushbutton **TRIG.** (24). The outer connector of the socket is galvanically connected to the earth wire (protective earth) of the mains (line).

**The calibrator and component tester controls as well as 3 sockets are situated below the CRT:**



(40) **COMP. TESTER** - Push button and two 4 mm banana sockets. Switching between oscilloscope and component tester operation is carried out with the button **COMP. TESTER** (component tester). See component Tester.

For component test operation, it will be automatically switched to analog mode and the Readout shows only "CT". All controls and LED indicators except "INTENS", "READ OUT" button (3), "TR" (4), "FOCUS" (5) and **SAVE/RECALL** (12) are disabled.

The testing of electronic components is carried out in two-terminal mode. One terminal of the component to be tested is connected to the 4mm socket beside the **COMP. TESTER** button. The other terminal is connected to the ground socket further to the left, which is galvanically con-

nected to the protective earth conductor of the mains (line). The last used conditions of the oscilloscope operation are restored when the component tester is switched off.

(41) **CAL.** - pushbutton with the related co-axial connector (outer conductor is galvanically connected to the protective earth conductor of the mains (line)).

As indicated by the front panel inscriptions a square wave signal of 1kHz with an amplitude of 0,2Vpp. is available at the socket when the push button is not depressed. When the button is depressed the frequency changes to around 1MHz. Both signals are used for frequency compensation of attenuator probes.

**Menu**

The instrument software contains a menu. This menu allows changes to the default settings regarding the instrument behaviour during operation, and a calibration option.

The menu can be called in the following way. After the oscilloscope is switched on and warmed up, the **HAMEG** logo and the software version („Rel. xx“) are displayed.

To enter the menu press and hold the **AUTO SET** button constantly until the internal test is completed successfully. Then the readout displays the headline „MAIN MENU“ and the submenus „**CALIBRATION**“ and „**SETUP**“.

One of the submenus "CALIBRATION" or "SETUP" of the "MAIN MENU" can be preselected by briefly pressing the **SAVE** or **RECALL** button (12). The preselected submenu will be highlighted. The preselected submenu can be called by pressing longer the **SAVE (SET)** button (12). Subsequently one of menu items in the submenu can be preselected by briefly pressing the **SAVE** or **RECALL** button (12). The preselected menu item will be highlighted. Pressing the **SAVE (SET)** longer either calls the function corresponding to the preselected menu item or switches the corresponding function from on to off or vice versa.

**item no 1: CONTROLS BEEP ON/OFF.** In OFF condition the acoustic signals actuated by the control limits are switched off. The actual setting is highlighted and can be changed by pressing and holding the **SAVE (SET function)** (12) button.

**item no 2: ERROR BEEP ON/OFF.** Acoustic signals indicating faulty control operation are suppressed in OFF condition. The actual setting is highlighted and can be changed by pressing and holding the **SAVE (SET function)** (12) button.

**Note:** The default setting regarding items 1 and 2 is ON. If different conditions are required the setting must be performed **each time after switching the oscilloscope on.**

**item no 3: QUICK START ON/OFF.** In condition ON the **HAMEG** logo and the menus will not be displayed after switching the instrument on. Then the instrument is quickly ready for operation. To change from **QUICK START OFF** to ON, press and hold the **AUTOSET** button when switching the instrument on until the menus become visible.

The ON/OFF information is not displayed in the readout if one of the following items (4 to 6) is selected. After one of these items

has been chosen, press and hold the SAVE (SET function) pushbutton (12) to call the function. This causes a warning to be displayed. If the function was called erroneously it can be left by pressing the AUTOSET pushbutton (2). Otherwise press and hold the SAVE (SET function) pushbutton (12) to enter the function.

**item no 4:** LOAD S/R DEFAULT (S/R = SAVE/RECALL). This overwrites all SAVE/RECALL memories with the following instrument setting: Single channel operation („CH1:500mV~“), timebase („T:100µs“), automatic peak value triggering and AC trigger coupling.

**item no 5:** RESTORE FACTORY DEFAULT. If inadvertently an adjustment was performed in CALIBRATE MENU condition, which was not stored by OVERWRITE FACTORY DEFAULT, the factory adjustments can be recalled by this function.

**item no 6:** OVERWRITE FACTORY DEFAULT. Attention! Calling this function causes the factory adjustments to be overwritten by new data. The factory adjustment then is lost and can not be recalled by RESTORE FACTORY DEFAULT.

This function is only intended for those cases in which an adjustment can be performed with very expensive 0% error calibrators, to adjust the instrument for optimum tolerance when operated under extreme environmental conditions.

## First Time Operation

The following text assumes that the „SAFETY“ section of this manual has been read carefully and understood.

Each time before the instrument is put into operation check that the oscilloscope is connected to protective earth. For that reason the power cable must be connected to the oscilloscope and the power outlet. Then the test lead(s) must be connected to the oscilloscope input(s). Check that the device under test is switched off and connect the test lead(s) to the test point(s). Then switch on the instrument and afterwards the device under test.

The oscilloscope is switched on by depressing the red POWER pushbutton. After a few seconds the HAMEG logo and the instrument software release is displayed on the screen. As long as the HAMEG logo is visible different internal checks are made. Thereafter the instrument will revert to its last used operating mode.

If after approx. 20 seconds no trace is visible, the AUTO SET pushbutton should be pressed briefly. This selects the Yt mode and medium trace and readout intensity (please note „AUTO SET“). Adjust Y-POS.I and X-POS. controls to center the baseline. Adjust INTENS. (intensity) and FOCUS controls for medium brightness and optimum sharpness (input(s) grounded) of the trace. The oscilloscope is now ready for use.

If the AUTO SET function was not used and only a spot appears (**CAUTION! CRT phosphor can be damaged**), reduce the intensity immediately and check that the XY mode is not selected (**XY** not displayed in the readout).

To obtain the maximum life from the cathode-ray tube, the minimum intensity setting necessary for the measurement in hand and the ambient light conditions should be used.

Particular care is required when a single spot is displayed, as a very high intensity setting may cause damage to the fluorescent screen of the CRT. Switching the oscilloscope off and on at short intervals stresses the cathode of the CRT and should therefore be avoided.

The instrument is so designed that even incorrect operation will not cause serious damage.

### Trace Rotation TR

In spite of Mumetal-shielding of the CRT, effects of the earth's magnetic field on the horizontal trace position cannot be completely avoided. This is dependent upon the orientation of the oscilloscope on the place of work. A centred trace may not align exactly with the horizontal center line of the graticule. A few degrees of misalignment can be corrected by a potentiometer accessible through an opening on the front panel marked **TR**.

### Probe compensation and use

To display an undistorted waveform on an oscilloscope, the probe must be matched to the individual input impedance of the vertical amplifier.

For this purpose a square wave signal with a very fast rise time and minimum overshoot should be used, as the sinusoidal contents cover a wide frequency range.

The built-in calibration generator provides a square wave signal with a very fast risetime (<4ns), and switch-selectable frequencies of approx. 1kHz and 1MHz from the output socket below the CRT screen.

As the squarewave signals are used for probe compensation adjustments, neither the frequency accuracy nor the pulse duty factor are of importance and therefore not specified.

The output provides 0.2Vpp ±1% (tr <4ns) for 10:1 probes. When the Y deflection coefficient is set to 5mV/div, the calibration voltage corresponds to a vertical display of 4 divisions (10:1 probe). The output socket has an internal diameter of 4.9mm to accommodate the internationally accepted shielding tube diameter of modern Probes and F-series slimline probes. Only this type of construction ensures the extremely short ground connections which are essential for an undistorted waveform reproduction of non-sinusoidal high frequency signals.

### Adjustment at 1kHz

The C-trimmer adjustment (low frequency) compensates the capacitive loading on the oscilloscope input. By this adjustment, the capacitive division assumes the same ratio as the ohmic voltage divider to ensure the same division ratio for high and low frequencies, as for DC. (For 1:1 probes or switchable probes set to 1:1, this adjustment is neither required nor possible). A baseline parallel to the horizontal graticule lines is essential for accurate probe adjustments. (See also „Trace rotation TR“).

Connect the probes (Types HZ51, 52, 54, or HZ36) to the CH I input. Set the deflection coefficient to 5mV/div and the input coupling to DC. The time deflection coefficient should be set to 0.2ms/div. All deflection coefficients should be calibrated. Plug the the probe tip into the calibrator output socket.



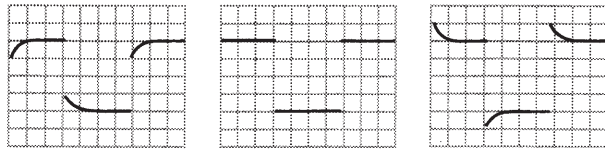

incorrect

correct

incorrect

Approximately 2 complete waveform periods are displayed on the CRT screen. The compensation trimmer should be adjusted. The location of the low frequency compensation trimmer can be found in the probe information sheet. Adjust the trimmer with the insulated screw driver provided, until the tops of the square wave signal are exactly parallel to the horizontal graticule lines (see 1kHz diagram). The signal height should then be  $4\text{div} \pm 0.16\text{div}$  (= 4 % (oscilloscope 3% and probe 1%). During this adjustment, the signal edges will remain invisible.

## Adjustment at 1MHz

Probes HZ51, 52 and 54 can also be HF-compensated. They incorporate resonance de-emphasizing networks (R-trimmer in conjunction with inductances and capacitors) which permit probe compensation in the range of the upper frequency limit of the vertical oscilloscope amplifier. Only this compensative adjustment ensures optimum utilisation of the full bandwidth, together with constant group delay at the high frequency end, thereby reducing characteristic transient distortion near the leading edge (e.g. overshoot, rounding, ringing, holes or bumps) to an absolute minimum.

Using the probes HZ51, 52 and 54, the full bandwidth of the oscilloscope can be utilized without risk of unwanted waveform distortion.

Prerequisite for this HF compensation is a square wave generator with fast risetime (typically 4ns), and low output impedance (approx.  $50\Omega$ ), providing 0.2V at a frequency of approx. 1MHz. The calibrator output of this instrument meets these requirements when the **CAL.** pushbutton is depressed.

Connect the probe to **CH.I** input. Depress the **CAL.** pushbutton for 1MHz. Operate the oscilloscope as described under 1kHz but select for  $0.2\mu\text{s}/\text{div}$  time deflection coefficient setting.

Insert the probe tip into the output socket. A waveform will be displayed on the CRT screen, with leading and trailing edges clearly visible. For the HF-adjustment now to be performed, it will be necessary to observe the rising edge as well as the upper left corner of the pulse top. The location of the high frequency compensation trimmer(s) can also be found in the probe information sheet. These R-trimmer(s) have to be adjusted such that the beginning of the pulse is as straight as possible. Overshoot or excessive rounding are unacceptable. The adjustment is relatively easy if only one adjusting point is present. In case of several adjusting points the adjustment is slightly more difficult, but causes a better result. The rising edge should be as steep as possible, with a pulse top remaining as straight and horizontal as possible.

After completion of the HF-adjustment, the signal amplitude displayed on the CRT screen should have the same value as during the 1kHz adjustment.

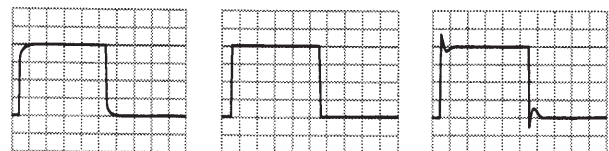

incorrect

correct

incorrect

Probes other than those mentioned above, normally have a larger tip diameter and may not fit into the calibrator output. Whilst it is not difficult for an experienced operator to build a suitable adapter, it should be pointed out that most of these probes have a slower risetime with the effect that the total bandwidth of scope together with probe may fall far below that of the oscilloscope. Furthermore, the HF-adjustment feature is nearly always missing so that waveform distortion can not be entirely excluded. The adjustment sequence must be followed in the order described, i.e. first at 1kHz, then at 1MHz. The calibrator frequencies should not be used for timebase calibration. The pulse duty cycle deviates from 1:1 ratio.

Prerequisites for precise and easy probe adjustments, as well as checks of deflection coefficients, are straight horizontal pulse tops, calibrated pulse amplitude, and zero-potential at the pulse base. Frequency and duty cycle are relatively uncritical. For interpretation of transient response, fast pulse risetimes and low-impedance generator outputs are of particular importance.

Providing these essential features, as well as switch-selectable output-frequencies, the calibrator of the instrument can, under certain conditions, replace expensive squarewave generators when testing or compensating wideband-attenuators or -amplifiers. In such a case, the input of an appropriate circuit will be connected to the **CAL.**-output via a suitable probe.

The voltage provided at a high-impedance input (1MW || 15-30pF) will correspond to the division ratio of the probe used ( $10:1 = 20\text{mVpp}$  output). Suitable probes are HZ51, 52, and 54.

## Operating modes of the vertical amplifiers in Yt mode.

The most important controls regarding the operation modes of the vertical amplifiers are the pushbuttons: CH I (22), DUAL (23) and CH II (26). Their functions are described in the section „Controls and Readout“.

In most cases oscilloscopes are used to display signals in Yt mode. Then the signal amplitude deflects the beam in vertical direction while the timebase causes an X deflection (from left to right) at the same time. Thereafter the beam becomes blanked and fly back occurs.

### The following Yt operation modes are available:

- Single channel operation of channel I (Mono CH I).
- Single channel operation of channel II (Mono CH II).
- Two channel operation of channel I and channel II (DUAL).
- Two channel operation of channel I and channel II, displaying the algebraic result as the sum or difference - (ADD).

The way the channel switching is determined in DUAL mode depends on the timebase setting and is described in the section „Controls and Readout“.

In **ADD** mode the signals of both channels are algebraically added and displayed as one signal. Whether the resulting display shows the sum or difference is dependent on the phase relationship or the polarity of the signals and on the invert function.

In **ADD** mode the following combinations are possible for

**In-phase input voltages:**

- No invert function active = sum.
- Channel II invert function active = difference.

**Antiphase input voltages:**

- No invert function active = difference.
- Channel II invert function active = sum.

In the **ADD** mode the vertical display position is dependent upon the **Y-POS.** setting of both channels. The same Y deflection coefficient is normally used for both channels with algebraic addition.

Please note that the Y-POS. settings are also added but are not affected by the INV setting.

Differential measurement techniques allow direct measurement of the voltage drop across floating components (both ends above ground). Two identical probes should be used for both vertical inputs. In order to avoid ground loops, use a separate ground connection and do not use the probe ground leads or cable shields.

**X-Y Operation**

The important control for this mode is the pushbutton labeled DUAL and **XY** (23). The following description refers to the XY analog mode.

Switching the operating mode is described in article (23) in section Controls and Readout. It also contains information about the differences in behavior of some of the controls in XY digital mode.

In XY mode the timebase is deactivated. The signal applied to the input of channel II - front panel marking HOR. INP. (X) - causes the X deflection. The input related controls (AC/DC, GD pushbutton and the VOLTS/DIV knob) consequently affect the X deflection. For X position alteration, the X-POS. control knob must be used, as the Y-POS. II control is automatically inactivated. The input deflection coefficient ranges are the same for both channels, because the X x10 magnifier is inactive in XY mode.

The bandwidth of the X amplifier, is lower than the Y amplifier and the phase angle which increases with higher frequencies, must be taken into account (please note data sheet).

**The inversion of the X-input signal is not possible.**

Lissajous figures can be displayed in the **X-Y** mode for certain measuring tasks:

- Comparing two signals of different frequency or bringing one frequency up to the frequency of the other signal. This also applies for whole number multiples or fractions of the one signal frequency.

- Phase comparison between two signals of the same frequency.

**Phase comparison with Lissajous figures**

The following diagrams show two sine signals of the same frequency and amplitude with different phase angles.

Calculation of the phase angle or the phase shift between the X and Y input voltages (after measuring the distances a and b on the screen) is quite simple with the following formula, and a pocket calculator with trigonometric functions. Apart from the reading accuracy, the signal height has no influence on the result.

**The following must be noted here:**

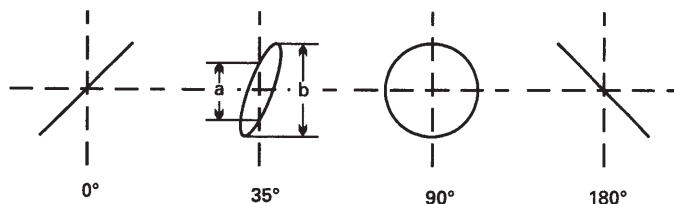

- Because of the periodic nature of the trigonometric functions, the calculation should be limited to angles  $\leq 90^\circ$ . However here is the advantage of the method.
- Due to phase shift, do not use a too high test frequency.

$$\sin \varphi = \frac{a}{b}$$

$$\cos \varphi = \sqrt{1 - \left(\frac{a}{b}\right)^2}$$

$$\varphi = \arcsin \frac{a}{b}$$

- It cannot be seen as a matter of course from the screen display if the test voltage leads or lags the reference voltage. A CR network before the test voltage input of the oscilloscope can help here. The 1 MΩ input resistance can equally serve as R here, so that only a suitable capacitor C needs to be connected in series. If the aperture width of the ellipse is increased (compared with C short-circuited), then the test voltage leads the reference voltage and vice versa. This applies only in the region up to 90° phase shift. Therefore C should be sufficiently large and produce only a relatively small just observable phase shift.

**Should both input voltages be missing or fail in the X-Y mode, a very bright light dot is displayed on the screen. This dot can burn into the phosphor at a too high brightness setting (INTENS. knob) which causes either a lasting loss of brightness, or in the extreme case, complete destruction of the phosphor at this point.**

## Phase difference measurement in DUAL mode (Yt).

Phase differences between two input signals of the same frequency and shape can be measured very simply on the screen in Dual mode. The timebase should be triggered by the reference signal (phase position 0). The other signal can then have a leading or lagging phase angle. In alternate triggering condition, phase difference measurement is not possible.

For greatest accuracy adjust the timebase for slightly over one period and approximately the same height of both signals on the screen. The Y deflection coefficients, the timebase coefficients and the trigger level setting can be used for this adjustment, without influence on the result. Both base lines are set onto the horizontal graticule center line using the **Y-POS.** knobs before the measurement. With sinusoidal signals, observe the zero (crossover point) transitions; the sine peaks are less accurate. If a sine signal is noticeably distorted by even harmonics, or if a **DC** voltage is present, **AC** coupling is recommended for both channels. If it is a question of pulses of the same shape, read off at steep edges.

It must be noted that the phase difference cannot be determined if alternate triggering is selected.

## Phase difference measurement in DUAL mode:

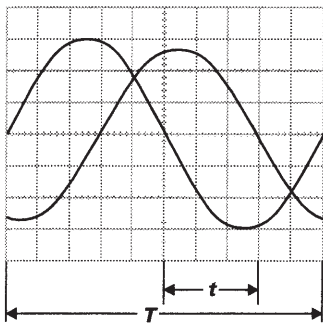

- t** = horizontal spacing of the zero transitions in div
- T** = horizontal spacing for one period in div

In the example illustrated,  $t = 3\text{div}$  and  $T = 10\text{div}$ . The phase difference in degrees is calculated from

$$\varphi^\circ = \frac{t}{T} \cdot 360^\circ = \frac{3}{10} \cdot 360^\circ = 108^\circ$$

$$\text{arc } \varphi^\circ = \frac{t}{T} \cdot 2\pi = \frac{3}{10} \cdot 2\pi = 1,885 \text{ rad}$$

Relatively small phase angles at not too high frequencies can be measured more accurately in the X-Y mode with Lissajous figures.

## Measurement of an amplitude modulation:

The momentary amplitude  $u$  at time  $t$  of a HF-carrier voltage, which is amplitude modulated without distortion by a sinusoidal AF voltage, is in accordance with the equation

$$u = U_T \cdot \sin \Omega t + 0,5m \cdot U_T \cdot \cos(\Omega - \omega) t - 0,5m \cdot U_T \cdot \cos(\Omega + \omega) t$$

where

- $U_T$**  = unmodulated carrier amplitude
- $\omega$**  =  $2\pi f$  = angular carrier frequency
- $\omega$**  =  $2\pi f$  = modulation angular frequency
- $m$**  = modulation factor (i.a.  $\approx 1$  100%).

The lower side frequency  **$F-f$**  and the upper side frequency  **$F+f$**  arise because of the modulation apart from the carrier frequency  **$F$** .

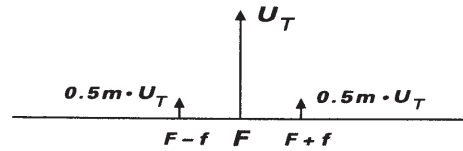

Figure 1  
Amplitude and frequency spectrum for AM display ( $m = 50\%$ )

The display of an amplitude-modulated HF oscillation can be evaluated with the oscilloscope provided the frequency spectrum is inside the oscilloscope bandwidth. The timebase is set so that several cycles of the modulation frequency are visible. Strictly speaking, triggering should be external with modulation frequency (from the AF generator or a demodulator). However, internal triggering is frequently possible with normal triggering using a suitable trigger level setting and possibly also using the time vernier (variable) adjustment.

Oscilloscope setting for a signal according to figure 2:

- Y: CH. I; 20mV/div; AC.
- TIME/DIV.: 0.2ms/div.
- Triggering: Normal; with LEVEL-setting; internal (or external) triggering.

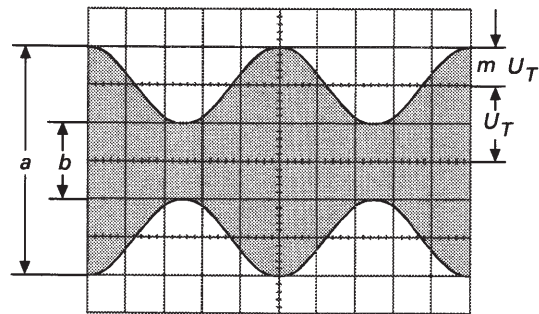

Figure 2  
Amplitude modulated oscillation:  $F = 1 \text{ MHz}$ ;  $f = 1 \text{ kHz}$ ;  $m = 50\%$ ;  $U_T = 28.3 \text{ mVrms}$ .

$$m = \frac{a - b}{a + b} \quad \text{bzw.} \quad m = \frac{a - b}{a + b} \cdot 100[\%]$$

If the two values  $a$  and  $b$  are read from the screen, the modulation factor is calculated from where

$$a = U_T (1+m) \quad \text{and} \quad b = U_T (1-m).$$

The variable controls for amplitude and time can be set arbitrarily in the modulation factor measurement. Their position does not influence the result.

## Triggering and timebase

All controls regarding trigger and timebase are located on the right of the VOLTS/DIV. knobs. They are described in the section „**Controls and Readout**“.

Time related amplitude changes on a measuring signal (AC voltage) are displayable in Yt-mode. In this mode the signal voltage deflects the beam in vertical direction (Y) while the timebase generator moves the beam from the left to the right of the screen (time deflection = t).

Normally there are periodically repeating waveforms to be displayed. Therefore the timebase must repeat the time deflection periodically too. To produce a stationary display, the timebase must only be triggered if the signal height and slope condition coincide with the former timebase start conditions. A DC voltage signal can not be triggered as it is a constant signal with no slope.

Triggering can be performed by the measuring signal itself (internal triggering) or by an external supplied but synchronous voltage (external triggering).

The trigger voltage should have a certain minimum amplitude. This value is called the trigger threshold. It is measured with a sine signal. Except when external trigger is used the trigger threshold can be stated as vertical display height in div, at which the timebase generator starts, the display is stable, and the trigger indicator LED lights or flashes.

The internal trigger threshold of the oscilloscope is given as  $\leq 5$ div. When the trigger voltage is externally supplied, it can be measured in  $V_{pp}$  at that input. Normally, the trigger threshold may be exceeded up to a maximum factor of 20.

The instrument has two trigger modes, which are characterized as Automatic Peak and Normal triggering.

### Automatic Peak (value) -Triggering

Instrument specific informations can be drawn from the items **NM - AT - J1** (16) and **LEVEL** (18) in the section „Controls and Readout“.

This trigger mode is automatically selected after the AUTO SET pushbutton was pressed. As the peak value detection makes no sense in combination with DC and TV (television) signals, it is switched off automatically in DC, TVL and TVF trigger coupling conditions as well as in alternate trigger mode. In this case the automatic is still present, but a wrong trigger level setting causes an untriggered display.

In automatic trigger mode the sweep generator can run without test signal or external trigger voltage. A base line will always be displayed even with no signal. With an applied **AC** signal the peak value triggering enables the user to select the voltage point on the trigger signal (trigger point), by the adjustment of the trigger level control. The control range depends on the peak to peak value of the signal. This trigger mode is therefore called Automatic Peak (Value)- Triggering. Operation of the scope needs only correct amplitude and timebase settings, for a constantly visible trace. Automatic mode is recommended for all uncomplicated measuring tasks. However, automatic triggering is also the appropriate operation mode for the „entry“ into difficult measuring problems, e.g. when the test signal is unknown relating to

amplitude, frequency or shape. Presetting of all parameters is now possible with automatic triggering; the change to normal triggering can follow thereafter.

The automatic triggering works above 20Hz. The failure of automatic triggering at frequencies below 20Hz is abrupt. However, it is not signified by the trigger indicator LED this is still blinking. Break down of triggering is best recognizable at the left screen edge (the start of the trace in differing display height).

The automatic peak (value) triggering operates over all variations or fluctuations of the test signal above **20Hz**. However, if the pulse duty factor of a square-wave signal exceeds a ratio of 100:1, switching over to normal triggering will be necessary. Automatic triggering is practicable with internal and external trigger voltage.

### Normal Triggering

Information specific to the instrument are given in the articles **NM - AT - J1** (16), **LEVEL** (18) and **TRIG. MODE** (27) in the section "Controls and Readout". The time fine adjustment (VAR.) and the hold off time setting assist in triggering under specially difficult signal conditions. The following description refers to the XY analog mode. Differences in digital mode are given in the articles already mentioned above in the section "Controls and Readout".

The description of the most important control elements **NM - AT - J1** (16) and **LEVEL** (18)) is part of the section „Controls and Readout“.

With normal triggering, the sweep can be started by AC signals within the frequency range defined by the trigger coupling setting.

In the absence of an adequate trigger signal or when the trigger controls (particularly the trigger LEVEL control) are misadjusted, no trace is visible, i.e. the screen completely blanked.

When using the internal normal triggering mode, it is possible to trigger at any amplitude point of a signal edge, even with very complex signal shapes, by adjusting the trigger LEVEL control. If the signal applied at the Y input is used for triggering (internal trigger source), its adjusting range is directly dependent on the display height, which should be at least 0.5div. If it is smaller than 1div, the trigger LEVEL adjustment needs to be operated with a sensitive touch. In the external normal triggering mode, the same applies to approx.  $0.3V_{pp}$  external trigger voltage amplitude.

Other measures for triggering of very complex signals are the use of the timebase variable control and HOLD OFF time control, hereinafter mentioned.

### Slope J1

**Please note item (16) in section „Controls and Readout“ for instrument specific information.**

The actual slope setting is displayed in the readout. The setting is not changed by the AUTO SET function. The slope setting can be changed in delay mode for the delay timebase trigger unit if the delay trigger function is active. The previous slope setting for the undelayed timebase trigger is stored and still active. For further information please note „**Controls and Readout**“.

The timebase generator can be triggered by a rising or falling edge of the test signal. Whether the rising or the falling edge is

used for triggering, depends on the slope direction setting. This is valid with automatic and normal triggering. The positive slope direction means an edge going from a negative potential and rising to a positive potential. This has nothing to do with zero or ground potential and absolute voltage values. The positive slope may also lie in a negative part of a signal.

However the trigger point may be varied within certain limits on the chosen edge using the LEVEL control. The slope direction is always related to the input signal and the non inverted display.

### Trigger coupling

Instrument specific information regarding this item can be noted in the „Data Sheet“. The coupling setting (**TRIG. MODE** (27)) and indication are described under „Controls and Readout“.

As the automatic triggering does not work below 20Hz, normal triggering should be used in DC and LF trigger coupling mode. The coupling mode and accordingly the frequency range of the trigger signal should meet the signal requirements.

**AC:** This is the most frequently used trigger mode. The trigger threshold increases below and above the frequency limits mentioned in the data sheet. This filter cuts off both the **DC** content of the trigger signal and the lowest frequency range.

**DC:** In this coupling mode the trigger signal is coupled galvanically to the trigger unit. Therefore there is no low frequency limit.

DC triggering is recommended if the signal is to be triggered with quite slow processes or if pulse signals with constantly changing pulse duty factors have to be displayed.

**HF:** In this coupling mode the transmission range equals a high pass filter. It cuts off the DC content of the trigger signal and the lower frequency range.

**LF:** LF trigger coupling has a low pass filter characteristic. As in DC trigger coupling, there is no low limit for the pass frequency range (galvanic coupling) in connection with normal triggering. The trigger signal is coupled through a capacitor in the automatic (peak value) triggering and LF trigger coupling. This results in a low frequency limit which, however, does not disturb as the limit is below the repetition frequency of the trigger automatic.

The LF trigger coupling is often more suitable for low frequency signals than DC trigger coupling because the noise components of the trigger signals are strongly suppressed. This avoids or reduces, under borderline conditions, jitter or double traces especially with very low signal voltages. The trigger threshold raises continuously above the pass band.

**TV-L:** The built-in active TV-Sync-Separator provides the separation of line sync pulses from the video signal. Even distorted video signals are triggered and displayed in a stable manner. This mode is described under paragraph „Triggering of video signals“.

**TV-F:** The built-in active TV-Sync-Separator also provides the separation of frame sync pulses from the video signal. Even distorted video signals are triggered and displayed in a sta-

ble manner. This mode is described under paragraph „Triggering of video signals“.

### Triggering of video signals

In **TV-L** and **TV-F** trigger coupling mode the instrument is automatically set to automatic triggering and the trigger point indicator is switched off. As only the separated synchronisation pulses are used for triggering the relationship between the displayed signal and the trigger signal is lost. In **TV-F** mode interference may occur if chopped **DUAL** mode is chosen or the readout is active.

Video signals are triggered in the automatic mode. The internal triggering is virtually independent of the display height, but the sync pulse must exceed 0.5div height.

The polarity of the synchronization pulse is critical for the slope selection. If the displayed sync pulses are above the picture (field) contents (leading edge positive going), then the slope setting for positive going edges must be chosen. In the case of sync pulses below the field/line, the leading edge is negative and consequently the slope selection must be set for falling edges. Since the invert function may cause a misleading display, it must not be activated.

On the **2ms/div** setting and **field TV** triggering selected, 1 field is visible if a 50 fields/s signal is applied. If the hold off control is in fully ccw position, it triggers without line interlacing affects caused by the consecutive field.

The display can be expanded by switching on the X-MAG. x10 function so that individual lines are recognizable. Commencing with a frame synchronizing pulse, the display can also be expanded with the knob TIME/DIV. But note that this can result in an apparently unsynchronized display as each frame (half picture) triggers. This is due to the off set of half a line between frames.

The influence of the integrating network which forms a trigger pulse from the vertical sync pulses may become visible under certain conditions. Due to the integrating network time constant not all vertical sync pulses starting the trace are visible.

On the **10µs/div** setting and **line TV** triggering selected, approx. 1½ lines are visible. Those lines originate from the odd and even fields at random.

The sync-separator-circuit also operates with external triggering. It is important that the voltage range (0.3Vpp to 3Vpp) for external triggering should be noted. Again the correct slope setting is critical, because the external trigger signal may not have the same polarity or pulse edge as the test signal displayed on the CRT. This can be checked, if the external trigger voltage itself is displayed first (with internal triggering).

In most cases, the composite video signal has a high DC content. With constant video information (e.g. test pattern or color bar generator), the DC content can be suppressed easily by AC input coupling of the oscilloscope amplifier. With a changing picture content (e.g. normal program), DC input coupling is recommended, because the display varies its vertical position on screen with AC input coupling at each change of the picture content. The DC content can be compensated using the **Y-POS.** control so that the signal display lies in the graticule area. Then the composite video signal should not exceed a vertical height of 6div.

## Line triggering (~)

The instrument specific information regarding this mode is part of the section „**Controls and Readout**“ paragraph **TRIG. MODE** (27).

This trigger mode is present if the ~ LED is lit (27). The trigger point symbol is inactive in line/mains trigger mode as there is no direct amplitude relationship between the trigger voltage and the signal voltage.

A voltage originating from mains/line (50 to 60Hz) is used for triggering purposes if the trigger coupling is set to ~. This trigger mode is independent of amplitude and frequency of the Y signal and is recommended for all mains/line synchronous signals. This also applies within certain limits, to whole number multiples or fractions of the line frequency. Line triggering can also be useful to display signals below the trigger threshold (less than 0.5div). It is therefore particularly suitable for measuring small ripple voltages of mains/line rectifiers or stray magnetic field in a circuit. In this trigger mode the slope direction pushbutton selects the positive or negative portion of the line/mains sinewave. The trigger level control can be used for trigger point adjustment.

Magnetic leakage (e.g. from a power transformer) can be investigated for direction and amplitude using a search or pick-up coil. The coil should be wound on a small former with a maximum of turns of a thin lacquered wire and connected to a BNC connector (for scope input) via a shielded cable. Between cable and BNC center conductor a resistor of at least 100Ω should be series-connected (RF decoupling). Often it is advisable to shield statically the surface of the coil. However, no shorted turns are permissible. Maximum, minimum, and direction to the magnetic source are detectable at the measuring point by turning and shifting the coil.

## Alternate triggering

This trigger mode can be selected in **DUAL** mode by pressing and holding the **TRIG.** pushbutton (24) if the preconditions are met (please note „**Controls and Readout**“). In the case of chopped **DUAL** mode, selecting alternate trigger mode automatically sets the instrument to **alternate DUAL** mode.

If the trigger coupling is set to AC, TV-L or TV-F, selecting alternate triggering automatically results in DC coupling conditions. Under line/mains triggering condition alternate triggering can not be chosen. Thus only the following trigger coupling modes are available in alternate trigger mode: DC, NR, HF and LF. The trigger point symbol and the peak value detection (in automatic trigger mode) are internally inactivated.

With alternate triggering it is possible to trigger two signals which are different in frequency (asynchronous). In this case the oscilloscope must be operated in **DUAL** alternate mode and internal triggering each input signal must be of sufficient height to enable trigger. To avoid trigger problems due to different DC voltage components, **AC input coupling** for both channels is recommended.

The internal trigger source is switched in alternate trigger mode in the same way as the channel switching system in **DUAL** al-

ternate mode, i.e. after each timebase sweep. Phase difference measurement is not possible in this trigger mode as the trigger level and slope setting are equal for both signals. Even with 180° phase difference between both signals, they appear with the same slope direction.

If signals are applied with a high frequency ratio (difference), the trace intensity then becomes reduced if the timebase is set to smaller time coefficients (faster sweep). This happens as the number of sweeps does not increase because it depends on the lower frequency signal, but with a faster sweep the phosphor becomes less activated.

## External triggering

The external trigger input is activated with the aid of the **TRIG.** (24) pushbutton (see „**Controls and Readout**“), if the trigger coupling is not set to line/mains trigger coupling. Then the internal trigger source is deactivated. As the external trigger signal applied at the **TRIG. EXT** socket normally has no relation to the signal height of the displayed signal, the trigger point symbol is switched off. The external trigger voltage must have a minimum amplitude of 0.3V<sub>pp</sub> and should not increase above 3V<sub>pp</sub>. The input impedance of the **TRIG. EXT.** socket is approx. 1MΩ || 15pF.

### ***The maximum input voltage of the input circuit is 100V (DC+peak AC).***

The external trigger voltage may have a completely different form from the test signal voltage, but must be synchronous with the test signal. Triggering is even possible in certain limits with whole number multiples or fractions of the test frequency.

It must be noted that a different phase angle between the measuring and the triggering signal may cause a display not coinciding with the slope selection setting.

The trigger coupling selection can also be used in external triggering mode.

## Trigger indicator „TR“

The following description applies to the „TR“ LED. Please note item (17) under „**Controls and Readout**“.

An LED on condition indicates that the trigger signal has a sufficient amplitude and the trigger level control setting is correct. This is valid with automatic and with normal triggering. By observing the trigger LED, sensitive trigger level adjustment is possible when normal triggering is used, particularly at very low signal frequencies. The indication pulses are of only 100ms duration.

Thus for fast signals the LED appears to glow continuously, for low repetition rate signals, the LED flashes at the repetition rate or at a display of several signal periods not only at the start of the sweep at the left screen edge, but also at each signal period.

In automatic triggering mode the sweep generator starts repeatedly without test signal or external trigger voltage. If the trigger signal frequency decreases the trigger automatic repetition frequency the sweep generator starts without awaiting the trigger pulse. This causes an untriggered display and a flashing trigger LED.

## HOLD OFF-time adjustment

### Only in analog mode:

For instrument specific information please note **DEL.POS.** (28) in section „**Controls and Readout**“.

If it is found that a trigger point cannot be found on extremely complex signals, even after careful adjustment of the trigger level control, a stable display may often be obtained using the holdoff control. This facility varies the holdoff time between two sweep periods approx. up to the ratio 10:1. Pulses or other signal waveforms appearing during this off period cannot trigger the timebase.

Particularly with burst signals or aperiodic pulse trains of the same amplitude, the start of the sweep can be delayed until the optimum or required time.

**A very noisy signal or a signal with a higher interfering frequency is at times displayed double. It is possible that trigger level adjustment only controls the mutual phase shift, but not the double display. The stable single display of the signal, required for evaluation, is easily obtainable by expanding the hold off time until one signal is displayed.**

A double display is possible with certain pulse signals, where the pulses alternately show a small difference of the peak amplitudes. Only a very exact **trigger level** adjustment makes a single display possible. The use of the holdoff control simplifies the right adjustment.

After specific use the holdoff control should be reset into its calibration detent (fully ccw), otherwise the brightness of the display is reduced drastically. The function is shown in the following figures.

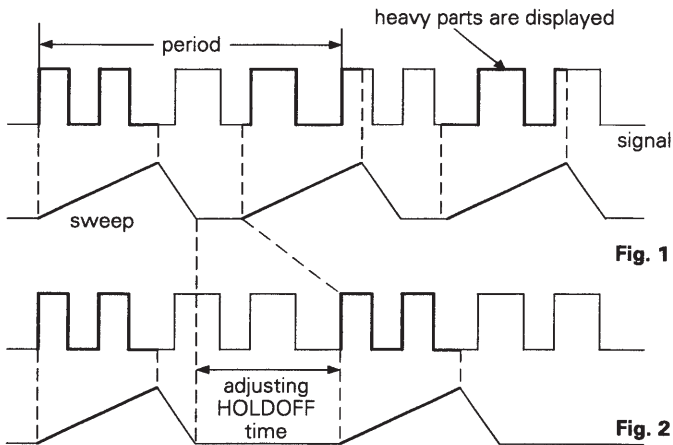

Fig. 1 shows a case where the holdoff control is in the minimum position and various different waveforms are overlapped on the screen, making the signal observation unsuccessful.

Fig. 2 shows a case where only the desired parts of the signal are stably displayed.

# Delay / After Delay Triggering

### Only in analog mode

The instrument specific information regarding this mode is part of the section „**Controls and Readout**“ paragraph **DEL. POS.** (28), **SEA. / DEL.** (30) and **DEL.TRIG.** (31).

As mentioned before, triggering starts the time base sweep and unblanks the beam. After the maximum X deflection to the right, the beam is blanked and flies back to the (left) start position. After the hold off period the sweep is started automatically by the automatic trigger or the next trigger signal. In normal triggering mode the automatic trigger is switched off and will only start on receipt of a trigger signal.

As the trigger point is always at the trace start position, trace expansion in X direction with the aid of the timebase is limited to the display on the left of the trace. Parts of the signal to be expanded which are displayed near the trace end (right side of the screen) are lost when the timebase speed is increased (time coefficient reduced).

The delay function delays the trace start by a variable time from the trigger point. This allows the sweep to begin on any portion of a signal. The timebase speed can then be increased to expand the display in X direction. With higher expansion rates, the intensity reduces and within certain limits this can be compensated by the **INTENS** knob setting.

If the display shows jitter, it is possible to select for (second) triggering after the elapsed delay time (**DTR**). As mentioned before, it is possible to display video signals using the frame sync pulses for triggering (TV-F). After the delay time set by the operator, the next line sync pulse or the line content may be used for triggering. So data lines and test lines can be displayed separately.

Operation of the delay function is relatively simple. Without delay function set the time coefficient setting (**TIME/DIV**) until 1 to 3 signal periods are displayed. Display of less the one period should be avoided as it limits the selection of the signal section to be expanded, and may cause trigger problems.

The X MAG (x10) function should be switched off and the time variable control should be CAL position. The signal must be triggered and stable. The following explanation assumes that the trace starts on the left vertical graticule line.

Photo 1 (composite video signal)

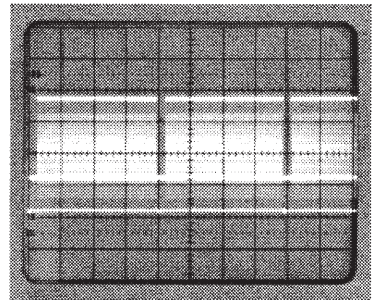

**MODE: undelayed**  
**TIME/DIV: 5ms/div**  
**Trigger coupling: TV-F**  
**Trigger slope: falling ( - )**

Pressing and holding the SEA./DEL. button switches over to SEARCH mode (SEA displayed by the readout).

In all delay modes, the DEL. POS. knob assumes the function of DEL. POS. (delay position), and the hold off time defaults to minimum. Now the function of this knob (DEL. POS.) is to adjust the delay time, indicated as a blanked part of the screen. The length of the blanked sector depends on the DEL. POS. setting and can be set between approx. one and six division after the normal trace start position. As the trace right end is not effected, the visible trace length is reduced. In delay (DEL) mode, the trace will start from the normal left end where the blanking starts. If the maximum delay is not sufficient, the time coefficient must be increased (TIME/DIV knob) and the DEL. POS. knob set to the later starting point. To return to normal (undelayed) timebase operation, press and hold the SEA./DEL pushbutton again.

Photo 2

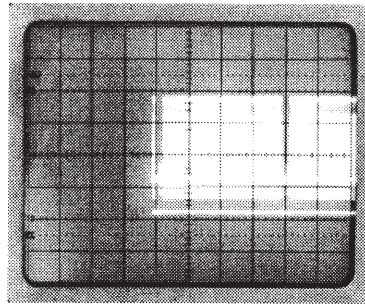

**MODE: SEA (SEARCH)**  
**TIME/DIV: 5ms/div**  
**Trigger coupling: TV-F**  
**Delay time: 4div x 5ms = 20ms**

Photo 2 shows that the delay time can be measured. It is identical with the displacement of the start of the trace. One can calculate this by multiplying the blanked out section (horizontal) by the time deflection coefficient setting.

The total trace starting with the previously selected section will be visible when switched from SEARCH to DELAY, providing the (stored) current time deflection coefficient is not too small.

If the trace is invisible or hardly visible because of too high expansion (too small deflection coefficient), the time deflection coefficient must be increased with TIME / DIV knob. A larger deflection coefficient than in the SEARCH mode cannot be set.

Example: The SEARCH setting selected in figure 2 is 5ms/div. The display in DELAY mode, also with 5ms/div is delayed but unexpanded (1:1). A further increase in the deflection coefficient, e.g. 10ms/div would be meaningless and therefore automatically blocked.

Please note that the previous time coefficient chosen in DEL and DTR mode is stored and automatically set after activating one of those modes. If the stored time coefficient in DEL or DTR mode was higher than the actual value in SEA (search) mode, the time coefficient in DEL or DTR mode is automatically set to the value used during SEA (search) operation.

Photo 3

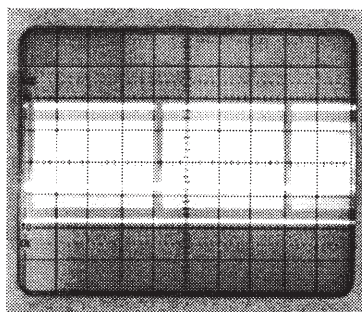

**MODE: DEL (DELAY)**  
**TIME/DIV: 5ms/div**  
**Trigger coupling: TV-F**  
**Trigger slope: falling ( - )**  
**Delay time: 20ms**

Reducing the time coefficient (increasing the time base speed) now expands the signal. If the signal start position is not set to the optimum, it can still be shifted in the X direction by turning the DEL. POS. knob. Photo 4 shows a 50 fold X magnification caused by setting the time coefficient to 0.1ms/div (5ms/div : 0.1ms/div = 50). The reading accuracy also increases with higher X magnification. As already mentioned, the time variable control must be in CAL position when measurements are taken.

Photo 4

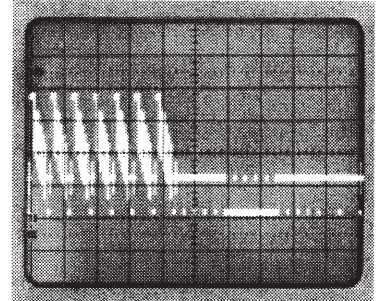

**MODE: DEL (DELAY)**  
**TIME/DIV: 0.1ms/div**  
**Trigger coupling: TV-F**  
**Trigger slope: falling ( - )**  
**Delay time: 20ms**

The delayed and expanded signal display can be triggered again if a signal slope suitable for triggering appears after the delay time. For this, one must switch to DEL.TRIG. (2nd triggering after the expiry of the delay time - after Delay Triggering). The settings selected before switching, automatic Peak value triggering / Normal triggering, trigger coupling, the trigger LEVEL setting and slope setting, remain valid and trigger the start of the delay time.

The "After Delay" Triggering automatically switches to normal triggering (indicated by the **NM** LED) and DC trigger coupling(not indicated). These default conditions cannot be changed. But the trigger level (LEVEL) and the trigger slope direction can be altered in order to enable the triggering at the desired signal section. The trace does not start and the screen remains blank if the signal amplitude is not sufficient for triggering or if the setting of the trigger LEVEL is unsuitable.

The expanded display can also be displaced in the X direction with DELAY position control (DEL.POS.) under suitable settings. However, the displacement is not continuous as in the untriggered DELAY operation but jumps from one trigger slope to another - with most signals this is not evident. This means, in the case of TV Triggering, that it is possible to trigger not only with line synchronizing pulses but also on suitable slopes occurring within the line.

Of course, the magnification is not restricted to a factor 50 as mentioned in the example. The limit is given by the increasing loss of trace intensity as the magnification is increased.

The manipulation of time delay requires a certain experience, especially with complicated signal combinations which are difficult to display. The recording of signal sections of simple signals is, in contrast, from the beginning fairly easy. The time delayed display is also possible in the dual channel, addition and difference modes.

**Attention:**  
**The display may be in chopped DUAL mode with DELAY operation in dual channel mode (DUAL). This is the case when in SEARCH, a time base between 50ms/div and 0,5ms/div is set which automatically switches in chopped DUAL mode.**



The chopped DUAL mode is effective even if subsequently the time base is switched to between 0,2ms/div and 50ns in triggered or untriggered DELAY operation. With highly expanded displays the channel switching will be visible during a sweep (alternately switching between channels I and II). One can then switch to alternate DUAL mode by simultaneously pressing the CHI and DUAL buttons. A renewed change in the time base setting will again result in chopped display but this can be overcome again.

## AUTO SET

The instrument specific information regarding this function is part of the section „**Controls and Readout**“ paragraph **AUTO SET (2)**. As also mentioned in that section all controls are electronically selected with the exception of the POWER and calibrator frequency (CAL 1kHz/1MHz) pushbuttons as well as the FOCUS and TR (trace rotation) control.

Thus automatic signal related instrument set up in Yt (timebase) mode is possible. In most cases no additional manual instrument setting is required.

Briefly pressing the **AUTO SET** pushbutton causes the instrument to switch over to the last Yt mode settings regarding **CH I**, **CH II** and **DUAL**. If the instrument was operated in Yt mode, the actual setting will not be affected with the exception of ADD mode which will be switched off. At the same time the attenuator(s) (**VOLTS/DIV**) are automatically set for a signal display height of approx. 6 div in mono channel mode or if in **DUAL** mode for approx. 4 div height for each channel. This and the following explanation regarding the automatic time coefficient setting assumes that the pulse duty factor of the input signal is approx. 1:1.

The time deflection coefficient is also set automatically for a display of approx. 2 signal periods. The timebase setting occurs randomly if complex signals consisting several frequencies e.g. video signals are present.

**AUTO SET** sets the instrument automatically to the following operating conditions:

- **AC** input coupling
- Internal triggering (channel I or channel II)
- Automatic peak (value) triggering
- Trigger level in electrical midrange position
- Y deflection coefficient(s) calibrated
- Timebase deflection coefficient calibrated
- **AC** trigger coupling (except DC trigger coupling)
- **SEARCH** and **DELAY** timebase mode switched **off**
- **X x10** magnifier **switched off**
- Automatic X and Y position settings
- Trace and readout visible.

If DC trigger coupling had been selected, AC trigger coupling will not be chosen and the automatic trigger is operative without the peak value detection.

The X position is set to the CRT centre as well as the Y position in CH I or CH II mode. In DUAL mode the channel I trace is set to the upper half and the channel II trace to the lower half of the CRT.

The 1mV/div and 2mV/div deflection coefficient will not be selected by AUTO SET as the bandwidth is reduced on these settings.

**Attention!**

**If a signal is applied with a pulse duty factor of approx. 400:1 or larger, an automatic signal display can not be performed. The pulse duty factor causes too low a Y deflection coefficient (sensitivity too high) and too high a time deflection coefficient (timebase speed to slow) and results in a display in which only the baseline is visible.**

In such cases it is recommended to select normal triggering and to set the trigger point approx. 0.5div above or below the trace. If under one of these conditions the trigger indicator LED is lit, this indicates the presence of a signal. Then both the time coefficient and Y deflection coefficient should be reduced. Please note that a reduction in intensity may occur, which could result in a blank screen when the physical limits are reached.

**STORAGE MODE ONLY**

In contrast to analog mode, intensity reduction does not occur. But it must be noted that pulses of less than 20ns width are displayed with too small amplitude. This is because of too few samples per pulse, as in 100MS/s condition (10ns sampling interval) only 4 samples are taken.

## SAVE/RECALL

The instrument specific information regarding the controls and their use are part of item (12) in section „**Controls and Readout**“.

The instrument contains a non volatile memory which can be used by the operator to save 9 different instrument settings and to recall them. This relates to all settings with the exception of **FOCUS**, **TR** (trace rotation) and the calibrator frequency pushbutton.

## Component Tester

**Only in analog mode**

**General**

The instrument specific information regarding the control and terminals are part of **item (40)** in section „**Controls and Readout**“.

The instrument has a built-in electronic Component Tester, which is used for instant display of a test pattern to indicate whether or not components are faulty. It can be used for quick checks of semiconductors (e.g. diodes and transistors), resistors, capacitors, and inductors. Certain tests can also be made to integrated circuits. All these components can be tested individually, or in circuit provided that it is unpowered.

The test principle is fascinatingly simple. A built-in generator delivers a sine voltage, which is applied across the component under test and a built-in fixed resistor. The sine voltage across the test object is used for the horizontal deflection, and the voltage drop across the resistor (i.e. current through test object) is used for vertical deflection of the oscilloscope. The test pattern shows a current-voltage characteristic of the test object.

The measurement range of the component tester is limited and depends on the maximum test voltage and current (please note data sheet). The impedance of the component under test is limited to a range from approx.  $20\Omega$  to  $4.7k\Omega$ . Below and above these values, the test pattern shows only short-circuit or open-circuit. For the interpretation of the displayed test pattern, these limits should always be born in mind. However, most electronic components can normally be tested without any restriction.

### Using the Component Tester

After the component tester is switched on, the vertical preamplifier and the timebase generator are inoperative. A shortened horizontal trace will be observed. It is not necessary to disconnect scope input cables unless in-circuit measurements are to be carried out.

For the component connection, two simple test leads with 4mm  $\varnothing$  banana plugs, and with test prod, alligator clip or sprung hook, are required. The test leads are connected as discribed in section „**Controls and Readout**“.

### Test Procedure

**Caution!**  
**Do not test any component in live circuitry - remove all grounds, power and signals connected to the component under test. Set up Component Tester as stated. Connect test leads across component to be tested. Observe oscilloscope display.**

 **Only discharged capacitors should be tested!**

### Test Pattern Displays

The page „Test patterns“ shows typical patterns displayed by the various components under test.

- Open circuit is indicated by a straight horizontal line.
- Short circuit is shown by a straight vertical line.

### Testing Resistors

If the test object has a linear ohmic resistance, both deflecting voltages are in the same phase. The test pattern expected from a resistor is therefore a sloping straight line. The angle of slope is determined by the resistance of the resistor under test. With high values of resistance, the slope will tend towards the horizontal axis, and with low values, the slope will move towards the vertical axis. Values of resistance from  $20\Omega$  to  $4.7k\Omega$  can be approximately evaluated. The determination of actual values will come with experience, or by direct comparison with a component of a known value.

### Testing Capacitors and Inductors

Capacitors and inductors cause a phase difference between current and voltage, and therefore between the X and Y deflection, giving an ellipse-shaped display. The position and opening width of the ellipse will vary according to the impedance value (at 50Hz) of the component under test.

A horizontal ellipse indicates a high impedance or a relatively small capacitance or a relatively high inductance.

A vertical ellipse indicates a small impedance or a relatively large capacitance or a relatively small inductance.

A sloping ellipse means that the component has a considerable ohmic resistance in addition to its reactance.

The values of capacitance of normal or electrolytic capacitors from  $0.1\mu F$  to  $1000\mu F$  can be displayed and approximate values obtained. More precise measurement can be obtained in a smaller range by comparing the capacitor under test with a capacitor of known value. Inductive components (coils, transformers) can also be tested. The determination of the value of inductance needs some experience, because inductors have usually a higher ohmic series resistance. However, the impedance value (at 50Hz) of an inductor in the range from  $20\Omega$  to  $4.7k\Omega$  can easily be obtained or compared.

### Testing Semiconductors

Most semiconductor devices, such as diodes, Z-diodes, transistors, FETs can be tested. The test pattern displays vary according to the component type as shown in the figures below.

The main characteristic displayed during semiconductor testing is the voltage dependent knee caused by the junction changing from the conducting state to the non conducting state. It should be noted that both the forward and the reverse characteristic are displayed simultaneously. This is a two-terminal test, therefore testing of transistor amplification is not possible, but testing of a single junction is easily and quickly possible. Since the test voltage applied is only very low, all sections of most semi-conductors can be tested without damage. However, checking the breakdown or reverse voltage of high voltage semiconductors is not possible. More important is testing components for open or short-circuit, which from experience is most frequently needed.

### Testing Diodes

Diodes normally show at least their knee in the forward characteristic. This is not valid for some high voltage diode types, because they contain a series connection of several diodes. Possibly only a small portion of the knee is visible. Zener diodes always show their forward knee and, depending on the test voltage, their zener breakdown forms a second knee in the opposite direction. If the breakdown voltage is higher than the positive or negative voltage peak of the test voltage, it can not be displayed.

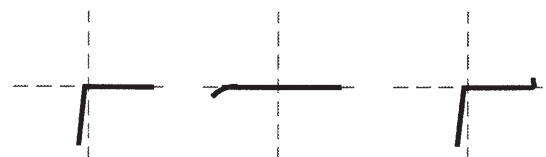

Type:	<i>Normal Diode</i>	<i>Highvolt.-Diode</i>	<i>Z-Diode 6.8V</i>
Terminals:	Cathode-Anode	Cathode-Anode	Cathode-Anode
Connections:	(CT-GD)	(CT-GD)	(CT-GD)

The polarity of an unknown diode can be identified by comparison with a known diode.

## Testing Transistors

Three different tests can be made to transistors: base-emitter, base-collector and emitter-collector. The resulting test patterns are shown below.

The basic equivalent circuit of a transistor is a Z-diode between base and emitter and a normal diode with reverse polarity between base and collector in series connection. There are three different test patterns:

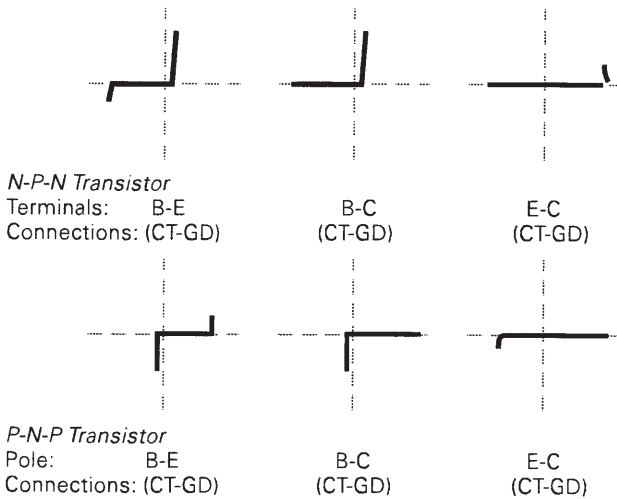

**For a transistor the figures b-e and b-c are important. The figure e-c can vary; but a vertical line only shows short circuit condition.**

These transistor test patterns are valid in most cases, but there are exceptions to the rule (e.g. Darlington, FETs). With the COMPONENT TESTER, the distinction between a P-N-P to an N-P-N

transistor is discernible. In case of doubt, comparison with a known type is helpful. It should be noted that the same socket connection (COMP. TESTER or ground) for the same terminal is then absolutely necessary. A connection inversion effects a rotation of the test pattern by 180 degrees round about the center point of the scope graticule.

## In-Circuit Tests

### Caution!

**During in-circuit tests make sure the circuit is dead. No power from mains/line or battery and no signal inputs are permitted. Remove all ground connections including Safety Earth (pull out power plug from outlet). Remove all measuring cables including probes between oscilloscope and circuit under test. Otherwise both COMPONENT TESTER leads are not isolated against the circuit under test.**

In-circuit tests are possible in many cases. However, they are not well defined. This is caused by a shunt connection of real or complex impedances - especially if they are of relatively low impedance at 50Hz - to the component under test, often results differ greatly when compared with single components. In case of doubt, one component terminal may be unsoldered. This terminal should then not be connected to the ground socket avoiding hum distortion of the test pattern.

Another way is a test pattern comparison to an identical circuit which is known to be operational (likewise without power and any external connections). Using the test prods, identical test points in each circuit can be checked, and a defect can be determined quickly and easily. Possibly the device itself under test contains a reference circuit (e.g. a second stereo channel, push-pull amplifier, symmetrical bridge circuit), which is not defective.

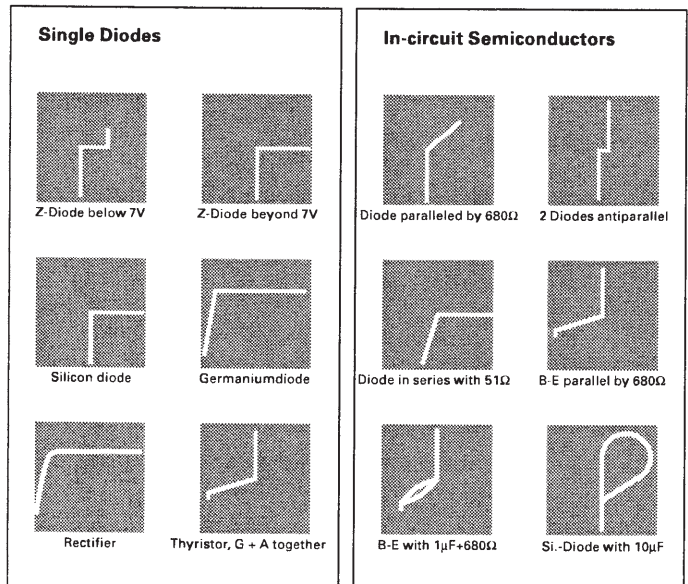
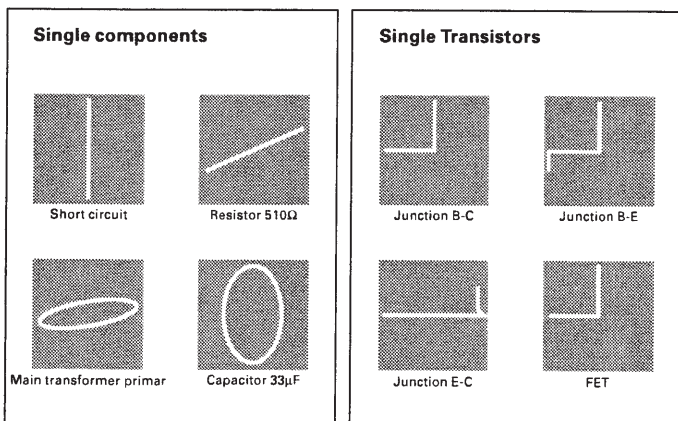

## STORAGE MODE

In contrast to analog mode, the storage mode offers the following advantages: One time events can be captured easily. Even very low frequency signals can be displayed as a complete curve. Narrow pulses with low repetition rates do not cause intensity reduction. Documentation and processing of captured signals is easily possible.

In comparison with analog mode, the disadvantages of storage mode are: The reduced X and Y resolution and a lower update rate. Danger of alias signal display, caused by a sampling rate (timebase setting) which is relatively too low with respect to the current signal.

The analog mode offers an unsurpassed faithful signal display. With the combination of analog and digital oscilloscope, HAMEG enables the user to select the most suitable mode for the specific measurement.

The **HM305-2** contains **two 8 bit flash A/D converters** with a maximum sampling rate of 50MS/s each. Except in the combination of DUAL mode and single event recording with a maximum of 50MS/s for each channel, in all other modes **100MS/s** is available if the lowest time coefficient is chosen.

Apart from the factors above, there is no principle difference between capturing repetitive signals and one-time events. The signal is always displayed with a linear connection between the dots (Dot Join function).

Signals captured and stored in storage mode can be called via the built-in RS232 interface for documentation purposes. For further information please note section „**RS232 Interface - Remote Control**“.

### Signal recording modes.

Signals can be recorded and displayed in six different modes:

<b>REFRESH</b>	mode ( <b>RFR</b> LED lit, readout indicates RFR)
<b>ENVELOPE</b>	mode ( <b>ENV</b> LED lit, readout indicates ENV)
<b>AVERAGE</b>	mode ( <b>AVM</b> LED lit, readout indicates AV...)
<b>SINGLE</b>	mode ( <b>SGL</b> LED lit, readout indicates SGL)
<b>ROLL</b>	mode ( <b>ROL</b> LED lit, readout indicates ROL)
<b>XY</b>	mode ( <b>RFR</b> LED lit, readout indicates XY and the sampling rate)

Except ROLL and XY mode, a signal recording in all other modes requires a trigger signal.

In REFRESH, ENVELOPE and AVERAGE modes the instrument behaves like an analog oscilloscope. The trigger circuit starts a recording, overwriting the previous recording from the left to the right side of the screen. After the recording has been finished, the next trigger event starts the same procedure. This can also be caused in automatic trigger mode without an applied signal by the automatic circuitry. Then only the trace (Y-POS. setting) is recorded.

In contrast to automatic trigger mode, in normal trigger mode the automatic system is switched off and consequently only a trigger signal can start a recording. Unlike analog mode where the screen is dark until a trigger signal starts the timebase, in

store mode the last recorded signal remains visible as long as no new recording is triggered by an input signal.

**AVERAGE** and **ENVELOPE** are REFRESH sub-modes and described in section „**Controls and Readout**“ under item (7).

**SINGLE** mode (SGL) enables the capture of one-time events, started by a suitable trigger signal. It is recommended, to select input ground (GD) condition and set the trace on a graticule line which is then used as the 0 Volt position (reference) line. In SINGLE mode the instrument is automatically set to normal trigger mode. After SINGLE (SGL) mode has been selected, the trigger point symbol should be set above or below the 0 Volt position line, according to the expected voltage of the event to be captured. Whether the slope selection is set for a rising or falling slope depends on the measurement task. After this procedure AC or DC input coupling must be selected and the signal capture started after pressing the RESET button. The following example is for additional explanation.

If a voltage drop on a +5 Volt line is expected, the 0 Volt line may be set to the horizontal center graticule line by using the Y-POS. control. Then the trigger point symbol may be set 2 division above the 0 Volt position using the **LEVEL** control.

If the deflection coefficient is set to 200mV and DC input coupling selected, using a x10 probe, the trigger point is at +4 Volts. A voltage drop from + 5 Volts below +4 Volts then is used for triggering, if negative slope setting is selected. If the slope selection is positive the end of the event (voltage drop ended) is used for triggering.

For explanations regarding **ROLL** mode, please note this item (7) in section „Readout and Controls“.

### Vertical resolution

The dot density in each operation mode is 8 bits =  $2^8 = 256$  dots displayed over a height of roughly 10 divisions. The instrument is adjusted for 25 dots per division. This eases processing and cursor measurement.

Insignificant differences between the (analog) screen display and the (digital) data are unavoidable.

This concerns signal height as well as the position. The trace position is defined in respect to the following horizontal graticule lines:

Center line	= 10000000 (binary)	= 80 (hex)	= 128 (dec).
Top line	= 11100100 (binary)	= E4 (hex)	= 228 (dec).
Bottom line	= 00011100 (binary)	= 1C (hex)	= 28 (dec).

In contrast to analog mode with its theoretically unlimited resolution, the vertical resolution has 25 possible trace positions per division.

If the signal is superimposed by noise or a critical Y-POS. setting is used, the least significant bit (LSB) may change continuously. This additionally reduces the vertical resolution in storage mode, but is unavoidable. In contrast to the expensive flash A/D converters used in this instrument, other converters such as CCD cause more noise.

## Horizontal resolution

The maximum number of signals to be displayed simultaneously is three. Each signal consists of 2048 ( $2^{11}$ ) byte (samples). Referred to the horizontal raster, the resolution is 200 samples per division.

Pure (only) digital oscilloscope with VGA monitor type CRTs offer only 50 samples per division. If LCD displays are used the current resolution is 25 samples per division. For a given timebase setting the HAMEG instrument samples at a 4 (compared to VGA) or 8 (referred to LCD) times higher sampling rate. The higher number of samples/div results in a shorter sampling interval. For the following example it must be kept in mind, that the timebase setting is related to the signal period duration and consequently should enable the display of one complete signal period. If e.g. a 50Hz signal has to be displayed the timebase should be set to 2ms/div. The maximum signal frequency of a superimposed sinewave signal, which must be sampled with at least 10 samples per period, depends on the horizontal resolution:

samples/div	sampling interval	sampling rate	max. frequency
200	2ms : 200 = 10 $\mu$ s	100kS/s	10kHz
50	2ms : 50 = 40 $\mu$ s	25kS/s	2.5kHz
25	2ms : 25 = 80 $\mu$ s	2.5kS/s	1.25kHz

During X magnifier mode the record length is still 2048 byte. The CRT displays a tenth of the recording (20 byte/division) plus 180 byte/div calculated in linear interpolation operation by a RISC processor. The smallest available time coefficient then is 100ns/div instead of 1 $\mu$ s/div without the X magnifier.

## Maximum signal frequency in storage mode

The highest capturable signal frequency cannot be exactly defined, since it depends to a large extent on the waveform.

With the start of each recording, the signal voltage at the input(s) of the analog-to-digital converters is briefly measured (sampled), converted to an 8-bit value and written to an address in RAM. The next sampled value is converted in the same way, but stored at the next RAM address.

The maximum sampling rate is 100MS/s. This yields a sampling interval of 10ns. Assuming that 10 measurements (samples) per signal period are sufficient for a sinewave signal, the maximum frequency to be captured is 10MHz (100ns per period).

## Alias signal display

If, due to the timebase setting, the sampling rate is too low, the display of an alias signal may occur. For example: A sinewave signal may be sampled only once per period. If the sinewave signal frequency is accidentally in phase with the sampling frequency and each sample is taken at the positive peak value, a straight line is displayed in this position.

Alias signal display may also occur in the form of an apparent untriggered waveform display of different frequency from the true signal. Another aliasing condition is the display of signals seeming to be amplitude modulated.

The easiest way to recognize alias signals is to switch to analog mode, where the true waveform is displayed. Transfer from analog to store mode without changing timebase range must produce the same frequency display.

## Operating modes of the vertical amplifiers

In principle, the instrument can operate in digital storage mode with the same operating modes as in analog mode. Thus, the following can be displayed:

- Channel I by itself
- Channel II by itself
- Channel I and II simultaneously
- The sum or difference of both channels
- XY mode

Storage mode differs from analog operation of the scope in the following respects:

- In DUAL mode (for simultaneous display of both channels), both input signals are also simultaneously captured, since each channel has its own A/D converter. In contrast to analog mode therefore, it is not necessary to switch between chopped and alternating mode.
- Because of the high display rate (approx. 80Hz) of the screen, no flicker can occur.
- The storage timebase is also active in XY storage mode.

# Test Instructions

## General

These Test Instructions are intended as an aid for checking the most important characteristics of the instrument at regular intervals without the need for expensive test equipment. Resulting corrections and readjustments inside the instrument, indicated by the following tests, are described in the „Service Manual“. They should only be undertaken by qualified personnel.

A chargeable „Service Manual“ is available from HAMEG. The „Service Manual“ describes the complete adjustment of the instrument in english language and contains the circuit diagrams as well as the component locations.

As with the First Time Operation instructions, care should be taken that all variable functions are set to their calibrated positions. This is the case if AUTO SET had been pressed. It is recommended to switch on the instrument for about 20 minutes prior to the commencement of any check.

## Cathode-Ray Tube:

Brightness and Focus, Linearity, Raster Distortion

Normally, the CRT of the instrument has very good brightness. Any reduction of this brightness can only be judged visually. Decreased brightness may be the result of reduced high voltage. In this case the sensitivity of the vertical amplifiers is significantly increased.

The control range for maximum and minimum brightness (intensity) must be such that the beam just disappears before reaching the left hand stop of the INTENS. control (particularly when in XY mode), while with the control at the right hand stop the focus and the line width are just acceptable.

With maximum intensity the timebase fly-back must on no account be visible. Visible trace fault without input signal: bright dot on the left side or decreasing brightness from left to right or shortening of the baseline. (Cause: Incorrect Unblanking Pulse.) It should be noted that with wide variations in brightness, refocusing is always necessary. Moreover, with maximum brightness, no „pumping“ of the display must occur. If pumping does occur, it is normally due to a fault in the regulation circuitry for the high voltage supply. The presetting pots for the high voltage circuit, minimum and maximum intensity, are only accessible inside the instrument.

A certain out-of-focus condition in the edge zone of the screen must be accepted. It is limited by standards of the CRT manufacturer. The same is valid for tolerances of the orthogonality, the undeflected spot position, the non-linearity and the raster distortion in the marginal zone of the screen in accordance with international standards (see CRT data book). These limit values are strictly supervised by HAMEG. The selection of a cathode-ray tube without any tolerances is practically impossible.

### Astigmatism Check

Check whether the horizontal and vertical sharpness of the display are equal. This is best seen by displaying a square-wave signal with the repetition rate of approximately 1MHz. Focus the horizontal tops of the square-wave signal at normal intensity, then check the sharpness of the vertical edges. If it is possible to improve this vertical sharpness by turning the FOCUS control, then an adjustment of the astigmatism control is necessary. A potentiometer of 47k $\Omega$  is provided inside the instrument for the correction of astigmatism. A certain loss of marginal sharpness of the CRT is unavoidable; this is due to the manufacturing process of the CRT. Symmetry and Drift of the Vertical Amplifier Both of these characteristics are substantially determined by the input stages of the amplifiers.

The symmetry of both channels and the vertical final amplifier can be checked by inverting Channel I and II (depress the corresponding INV pushbutton). The vertical position of the trace should not change by more than 0.5div. However, a change of 1div is just permissible. Larger deviations indicate that changes have occurred in the amplifier.

A further check of the vertical amplifier symmetry is possible by checking the control range of the Y-POS. controls. A sine-wave signal of 10-100kHz is applied to the amplifier input. When the Y-POS. control is then turned fully in both directions from stop to stop with a display height of approximately 8div, the upper and lower positions of the trace that are visible should be approximately of the same height. Differences of up to 1div are permissible (input coupling should be set to AC).

Checking the drift is relatively simple. 20minutes after switching on the instrument, set the baseline exactly on the horizontal center line of the graticule. The beam position must not change by more than 0.5div during the following hour.

### Calibration of the Vertical Amplifier

A square-wave voltage of 0.2Vpp  $\pm$ 1% is present at the output socket of the calibrator (CAL.) If a direct connection is made between the 0.2V output and the input of the vertical amplifier

(e.g. using a x1 probe), the displayed signal in the 50mV/div position (variable control to CAL.) should be 4div high (DC input coupling). Maximum deviations of 0.12div (3%) are permissible. If a x10 probe (1%) is connected between the 0.2V output and Y input, the deflection coefficient should be set to 5mV/div. Then the maximum deviation is 0.16div.

With higher tolerances it should first be investigated whether the cause lies, within the amplifier or in the amplitude of the square-wave signal. On occasions it is possible that the probe is faulty or incorrectly compensated. If necessary the measuring amplifier can be calibrated with an accurately known DC voltage (DC input coupling). The trace position should then vary in accordance with the deflection coefficient set.

With variable control in the attenuator sector fully counter-clockwise, the input sensitivity is decreased at least by the factor 2.5 in each position. In the 50mV/div position, the displayed calibrator signal height should vary from 4div to at least 1.6div.

### Transmission Performance of the Vertical Amplifier

The transient response and the delay distortion correction can only be checked with the aid of a square-wave generator with a fast risetime (max. 5ns). The signal coaxial cable (e.g. HZ34) must be terminated at the vertical input of the oscilloscope with a resistor equal to the characteristic impedance of the cable (e.g. with HZ22). Checks should be made at 100Hz, 1kHz, 10kHz, 100kHz and 1MHz, the deflection coefficient should be set at 5mV/div with DC input coupling. In so doing, the square pulses must have a flat top without ramp-off, spikes and glitches; no overshoot is permitted, especially at 1MHz and a display height of 4-5div. At the same time, the leading top corner of the pulse must not be rounded. In general, no great changes occur after the instrument has left the factory, and it is left to the operators discretion whether this test is undertaken or not. A suited generator for this test is **HZ60** from HAMEG.

Of course, the quality of the transmission performance is not only dependent on the vertical amplifier. The input attenuators, located in the front of the amplifier, are frequency-compensated in each position. Even small capacitive changes can reduce the transmission performance. Faults of this kind are as a rule most easily detected with a square-wave signal with a low repetition rate (e.g. 1kHz). If a suitable generator with max. output of 40Vpp is available, it is advisable to check at regular intervals the deflection coefficients on all positions of the input attenuators and readjust them as necessary. A compensated 2:1 series attenuator is also necessary, and this must be matched to the input impedance of the oscilloscope. This attenuator can be made up locally. It is important that this attenuator is shielded. For local manufacture, the electrical components required are a 1MW  $\pm$ 1% resistor and, in parallel with it, a trimmer 3-15pF in parallel with approx. 10pF. One side of this parallel circuit is connected directly to the input connector of CH I or CH II and the other side is connected to the generator, if possible via a low-capacitance coaxial cable. The series attenuator must be matched to the input impedance of the oscilloscope in the 5mV/div position (variable control to CAL., DC input coupling; square tops exactly horizontal; no ramp-off is permitted). This is achieved by adjusting the trimmer located in the 2:1 attenuator. The shape of the square-wave should then be the same in each input attenuator position.

### Operating Modes:

#### CH.I/II, DUAL, ADD, CHOP, INVERT and X-Y Operation

In DUAL mode two traces must appear immediately. On actuation of the Y-POS. controls, the trace positions should have minimal effect on each other. Nevertheless, this cannot be entirely avoided, even in fully serviceable instruments. When one trace is shifted vertically across the entire screen, the position of the other trace must not vary by more than 0.5mm.

A criterion in chopped operation is trace widening and shadowing around and within the two traces in the upper or lower region of the screen. Set time coefficient to 0.5ms/div, set input coupling of both channels to GD and advance the INTENS. control fully clockwise. Adjust FOCUS for a sharp display. With the Y-POS. controls shift one of the traces to a +2div, the other to a -2div vertical position from the horizontal center line of the graticule.

Do not try to synchronize (with the time variable control) the chop frequency (0.5MHz)! Check for negligible trace widening and periodic shadowing when switching between 0.5ms/div and 0.2ms/div.

It is important to note that in the I+II add mode or the I-II difference mode the vertical position of the trace can be adjusted by using both the Channel I and Channel II Y-POS. controls.

In X-Y Operation, the sensitivity in both deflection directions will be the same. When the signal from the built-in square-wave generator is applied to the input of Channel II, then, as with Channel I in the vertical direction, there must be a horizontal deflection of 4div when the deflection coefficient is set to 50mV/div position. The check of the mono channel display is unnecessary; it is contained indirectly in the tests above stated.

#### Triggering Checks

The internal trigger threshold is important as it determines the display height from which a signal will be stably displayed. It should be approx. 0.3-0.5div for the instrument. An increased trigger sensitivity creates the risk of response to the noise level in the trigger circuit. This can produce double-triggering with two out-of-phase traces.

Alteration of the trigger threshold is not required. Checks can be made with any sine-wave voltage between 50Hz and 1MHz. The instrument should be in automatic peak (value) triggering (NM LED dark) and the LEVEL knob in electrical midrange position. It should be ascertained whether the same trigger sensitivity is also present with Normal Triggering (NM LED lights). In this trigger mode, LEVEL adjustment is absolutely necessary.

The checks should show the same trigger threshold with the same frequency. On changing the trigger slope, the start of the sweep changes from the positive-going to the negative-going edge of the trigger signal.

As described in the Operating Instructions, the trigger frequency range is dependent on the trigger coupling selected. For lower frequencies the LF coupling mode can be selected. In this mode, triggering up to at least 1.5kHz (sine-wave) is possible. Internally the instrument should trigger perfectly at a display height of approx. 0.5div, when the appropriate trigger coupling mode is set.

For external triggering, the external trigger input connector requires a signal voltage of at least 0.3Vpp, which is in synchronism with the Y input signal. The voltage value is dependent on the frequency and the trigger coupling mode (AC-DC-HF-LF).

Checking of the TV triggering is possible with a video signal of any given polarity.

Use the TV-L or TV-F setting for video sync pulse separation. The correct slope of the sync pulse (front edge) must be selected and a suitable time coefficient setting must be chosen. The slope is then valid for both sync frequencies.

Perfect TV triggering is achieved, when in both display modes the amplitude of the complete TV signal (from white level to the top of the line sync pulse) is limited between 0.8 and 6div and sync pulses of more than 0.5 div height. The display should not shift horizontally during a change of the trigger coupling from AC to DC when displaying a sine-wave signal without DC offset.

If both vertical inputs are AC coupled to the same signal and both traces are brought to coincide exactly on the screen, when working in the alternate dual channel mode, then no change in display should be noticeable, when switching from TRIG CHI to TRIG CHII or when the trigger coupling is changed from AC to DC.

Checking of the line/mains frequency triggering (50-60Hz) is possible, when the input signal is time-related (multiple or submultiple) to the power line frequency (~ LED lights). There is no trigger threshold visible in this trigger mode. Even very small input signals are triggered stably (e.g. ripple voltage). For this check, use an input of approx. 1V. The displayed signal height can then be varied by turning the respective input attenuator switch and its variable control.

#### Timebase

Before checking the timebase it should be ascertained that the trace length is approx. 10div in all time ranges. The X-MAG. x10 LED should not light. This condition should be maintained until the variation ranges of these controls are checked. Check that the sweep runs from the left to the right side of the screen (TIME/DIV. setting to 100ms/div). This check is only necessary after changing the cathode-ray tube.

If a precise marker signal is not available for checking the Timebase time coefficients, then an accurate sine-wave generator may be used. Its frequency tolerance should not be greater than  $\pm 0.1\%$ . The timebase accuracy of the instrument is given as  $\pm 3\%$ , but it is considerably better than this. For the simultaneous checking of timebase linearity and accuracy at least 10 oscillations, i.e. 1 cycle every div, should always be displayed. For precise determination, set the peak of the first marker or cycle peak exactly behind the first vertical graticule line using the X-POS. control. Deviation tendencies can be noted after some of the marker or cycle peaks. If a precise Time Mark Generator is used for checking, Normal Triggering and LEVEL control adjustment is recommended.

The signal frequency required for each time coefficient setting can be determined easily by the aid of the readout. In time measurement condition the distance of the vertical cursor lines must be set to exactly 1 div. Then both readout information regarding the time deflection coefficient and the time difference show exactly the same value. After switching over from time to frequency measurement, the readout displays the required signal frequency in each timebase setting.

### Hold Off time (analog mode only)

The variation of the hold off time setting can not be measured without opening the instrument. However, a visual check can be made if the instrument is operated in undelayed timebase mode. Without an input signal, set time base to 50ns/div, use automatic peak (value) triggering. With minimum hold off time the trace should be bright. It should noticeably darken if the hold off time is increased to the maximum.

### Component Tester

After selecting component tester mode, a horizontal straight line should appear immediately, when the test leads are not connected (open circuit). The length of this trace should be approx. 8div. With the test leads shorted together, a vertical straight line with approx. 6div height should be displayed. The above stated measurements have some tolerances.

### Trace Alignment

The CRT has an admissible angular deviation  $\pm 5^\circ$  between the X deflection plane D1-D2 and the horizontal center line of the internal graticule. This deviation, due to tube production tolerances (and only important after changing the CRT), and also the influence of the earth's magnetic field, which is dependent on the instruments North orientation, are corrected by means of the TR potentiometer. In general, the trace rotation range is asymmetric. It should be checked, whether the baseline can be adjusted somewhat sloping to both sides round about the horizontal center line of the graticule. With the instrument in its closed case, an angle of rotation  $\pm 0.57^\circ$  (0.1div difference in elevation per 10div graticule length) is sufficient for the compensation of the earth's magnetic field.

## Service Instructions

### General

The following instructions are intended as an aid for the electronic technician, who is carrying out readjustments on the instrument, if the nominal values do not meet the specifications. These instructions primarily refer to those faults, which were found after using the Test Instructions. However, this work should only be carried out by properly qualified personnel. For any further technical information call or write to HAMEG. Addresses are provided at the back of the manual. It is recommended to use only the original packing material, should the instrument be shipped to for service or repair (see also Warranty).

### Instrument Case Removal

The rear cover can be taken off after unplugging the power cords triple-contact connector and after two nuts have been removed. If a cross recessed pan head screw is present on the bottom of the instrument, it must be removed too. While the instrument case is firmly held, the entire chassis with its front panel can be withdrawn forward. When the chassis is inserted into the case later on, it should be noticed that the case has to fit under the flange of the front panel. The same applies for the rear of the case, on which the rear cover is put.

#### Caution !

**During opening or closing of the case, the instrument must be disconnected from all power sources for maintenance work or a change of parts or components. If a measurement, trouble-shooting, or an adjustment is unavoidable, this work must be done by a specialist, who is familiar with the risk involved.**

When the instrument is set into operation after the case has been removed, attention must be paid to the acceleration voltage for the CRT approx. -2025V and to the operating voltages for both final amplifier stages 175V and 146V. Potentials of these voltages are on the PS-Board, the CRT-PCB and on the main PCB. They are highly dangerous and therefore precautions must be taken. It should be noted furthermore that shorts occurring on different points of the CRT high voltage and unblanking circuitry will definitely damage some semiconductors. For the same reason it is very risky to connect capacitors to these points while the instrument is on.

Capacitors in the instrument may still be charged, even when the instrument is disconnected from all voltage sources. Normally, the capacitors are discharged approx. 6 seconds after switching off. However, with a defective instrument an interruption of the load is not impossible. Therefore, after switching off, it is recommended to connect one by one all terminals across 1k $\Omega$  to ground (chassis) for a period of 1 second.

#### Caution

**Handling of the CRT needs utmost caution. The glass bulb must not be allowed under any circumstances to come into contact with hardened tools, nor should it undergo local superheating (e.g. by soldering iron) or local undercooling (e.g. by cryogenic-spray). We recommend the wearing of safety goggles (implosion danger).**

If any work has been carried out, the complete instrument (with case closed and POWER button depressed) must undergo a safety test, including a voltage test with 2200V DC, between accessible parts to both mains/line supply terminals. This test is dangerous and requires an adequately trained specialist. The maximum impedance between each accessible metallic part and the safety earth connector at the 3-pole power connector must be less than 0.1 $\Omega$ .

### Operating Voltages

The operating voltages (+12V, -6V, -2025V) are stabilized by the switch mode power supply. The +12V supply is further stabilized and used as a reference voltage for -6V stabilisation. These different operating voltages are fixed voltages, except the +12V, which can be adjusted. The variation of the fixed voltages greater than 5% from the nominal value indicates a fault. Measurements of the high voltage may only be accomplished by the use of a sufficient highly resistive voltmeter (>10M $\Omega$ ). You must make absolutely sure that the electric strength of the voltmeter is sufficiently high. It is recommended to check the ripple and also the interaction from other possible sources. Excessive values might be very often the reason for incomprehensible faults.



### Maximum and Minimum Brightness

A variable resistor (100k $\Omega$ ), located on the CRT PCB, is used for this adjustment procedure. It may only be touched by a properly insulating screwdriver (Caution! High voltage!). Correct adjustment is achieved, when the trace can be blanked in XY analog mode and, in addition, when the requirement described in the Test Instructions are met.

### Astigmatism control

The ratio of vertical and horizontal sharpness can be adjusted by the variable resistor of 47k $\Omega$ , located on the CRT PCB. As a precaution however, the voltage for the vertical deflecting plates (approx. +71V when the trace is in center position) should firstly be checked, because this voltage will affect the astigmatism correction. While the adjustment is being carried out (with medium brightness and a 1MHz square-wave signal), the upper horizontal square-wave tops are firstly focussed with the FOCUS control. Then the sharpness of the vertical lines are corrected with the 47k $\Omega$  Astigm. pot. The correction should be repeated several times in this sequence. The adjustment is optimised, when the FOCUS knob exclusively brings no improvement of the sharpness in both directions.

### Trigger Threshold

The internal trigger threshold should be in the range 0.3 to 0.5div display height.

### Trouble-Shooting the Instrument

For this job, at least an isolating variable mains/line transformer (protection class II), a signal generator, an adequate precise multimeter, and, if possible, an oscilloscope are needed. This last item is required for complex faults, which can be traced by the display of signal or ripple voltages. As noted before, the regulated high voltage and the supply voltages for the final stages are highly dangerous. Therefore it is recommended to use totally insulated extended probe tips, when trouble-shooting the instrument. Accidental contact with dangerous voltage potentials is then unlikely. Of course, these instructions cannot thoroughly cover all kinds of faults. Some common-sense will certainly be required, when a complex fault has to be investigated.

If trouble is suspected, visually inspect the instrument thoroughly after removal of the case. Look for loose or badly contacted or discolored components (caused by overheating). Check to see that all circuit board connections are making good contact and are not shorting to an adjacent circuit. Especially inspect the connections between the PCBs. This visual inspection can lead to success much more quickly than a systematic fault location using measuring instruments. Prior to any extensive trouble-shooting, also check the external power source.

If the instrument fails completely, the first and important step - after checking the power fuses - will be to measure the deflecting plate voltages of the CRT. In almost any case, the faulty section can be located.

The sections represent:

1. Vertical deflection.
2. Horizontal deflection.
3. CRT circuit.
4. Power supply.

While the measurement takes place, the position controls of both deflection devices must be in mid-position. When the deflection devices are operating properly, the separate voltages of each plate pair are almost equal then (Y approx. 71V and X approx 90V). If the separate voltages of a plate pair are very different, the associated circuit must be faulty. An absent trace in spite of correct plate voltages means a fault in the CRT circuit. Missing deflection plate voltages is probably caused by a defect in the power supply.

### Adjustments

As advised in the Operating, Test and Service Instructions, small corrections and adjustments are easily carried out with the aid of the „Service Manual“. However, a complete recalibration of the scope should not be attempted by an inexperienced operator, but only someone with sufficient expertise. Several precision measuring instruments with cables and adapters are required, and only then should the pots and trimmers be readjusted, provided that the result of each adjustment can be exactly determined. Thus for each operating mode and switch position, a signal with the appropriate sine or square waveform, frequency, amplitude, risetime and duty cycle is required.

As described in the „Menu“ section, the instrument's software contains the submenu „CALIBRATE“. The following items can be used by operators not equipped with precision instruments.

After the required warm-up time of 20 minutes, first the instrument must be switched off and on again with the **AUTO SET** button pressed constantly until the main menu becomes visible. In the „CALIBRATE“ submenu three items can be chosen:

- 1: Y AMP (amplifier channel I and II)
- 2: TRIGGER AMP (trigger amplifier channel I and II)
- 3: STORE AMP (digital section)

Attention! During the automatic adjustment procedure no signal may be applied on any input.

Each item is called by pressing the **CURSOR ON/OFF** button. Then the instrument automatically adjusts and stores the adjustment values. In case of the Y amplifiers these are the field effect transistor's operating points, the invert and the variable gain balance. For the trigger amplifier it is regarding the DC operating points and the trigger threshold. In storage mode the adaption of the storage display to the analog display.

The new adjustment values are always present after the instrument is switched on. Therefore it is not required to overwrite the factory adjustments by calling the **OVERWRITE FACTORY DEFAULT** function in the **SETUP** menu. Note! The automatic adjustment should only be made if the instrument's warm up time has passed and no faults such as incorrect operating voltages are present. During the automatic adjustment procedures the readout indicates „Working“.

# RS232 Interface - Remote-Control

## Safety

### Caution:

**All terminals of the RS232 interface are galvanically connected with the oscilloscope and subsequently with protective (safety) earth potential.**

Measurement on a high level reference potential is not permitted and endangers operator, oscilloscope, interface and peripheral devices.

In case of disregard of the safety warnings contained in this manual, HAMEG refuses any liability regarding personal injury and/or damage of equipment.

## Operation

The oscilloscope is supplied with a serial interface for control purposes. The interface connector (9 pole D- SUB female) is located on the rear of the instrument. Via this bidirectional port, the instrument parameter settings and (in storage mode) signal data, can be transmitted to, or received from a PC.

## RS-232 Cable

The maximum connecting cable length must not exceed 3 meters and must contain 9 lines connected 1:1. The oscilloscope RS232 connection (9 pole D-SUB female) is determined as follows:

Pin	
2	Tx data (data from oscilloscope to external device)
3	Rx data (data from external device to oscilloscope)
7	CTS (clear to send)
8	RTS (request to send)
5	Ground (reference potential - connected via the oscilloscope's power cord with protective earth)
9	+5V supply voltage for external devices (max. 400mA)

The maximum voltage swing at pin 2, 3, 7 and 8 is  $\pm 12$  volt.

## RS-232 protocol

N-8-2 (no parity bit, 8 data bits, 2 stop bits, RTS/CTS hardware protocol).

## Baud-Rate Setting

After the first POWER UP (switching on of the oscilloscope) and the first command SPACE CR (20hex, 0Dhex) sent from the PC, the baud rate is recognized and set automatically between 110 baud and 19200 baud. The oscilloscope is then switched over to REMOTE control mode. The oscilloscope then transmits the RETURN CODE: 0 CR LF to the PC. In this status all settings (with the exception of those functions mentioned under „Controls and Readout“) can be controlled via the interface only.

The only ways to quit this status are:

- Switching the oscilloscope off, transmitting the command
- RM= 0 from the PC to the oscilloscope, or
- depressing the AUTO SET ( LOCAL ) pushbutton, if in unlocked condition (command LK=1... was not sent)

After the remote state has been switched off the RM-LED (3) is dark.

Please note: A minimum time must elapse between the commands RM=1... (remote on) and RM=0... (remote off) and vice versa. The time can be calculated with the formula:  $t_{min} = 2x(1/\text{baud rate}) + 60\mu s$ .

If at the beginning no SPACE CR command is recognizable, the oscilloscope pulls the TxD line low for approx. 0.2ms and causes a break on the PC.

## Data Communication

After successfully being set to remote control mode, the oscilloscope is prepared for command reception.

Software is supplied with the instrument. It contains the program SP107, programming examples and a command list.

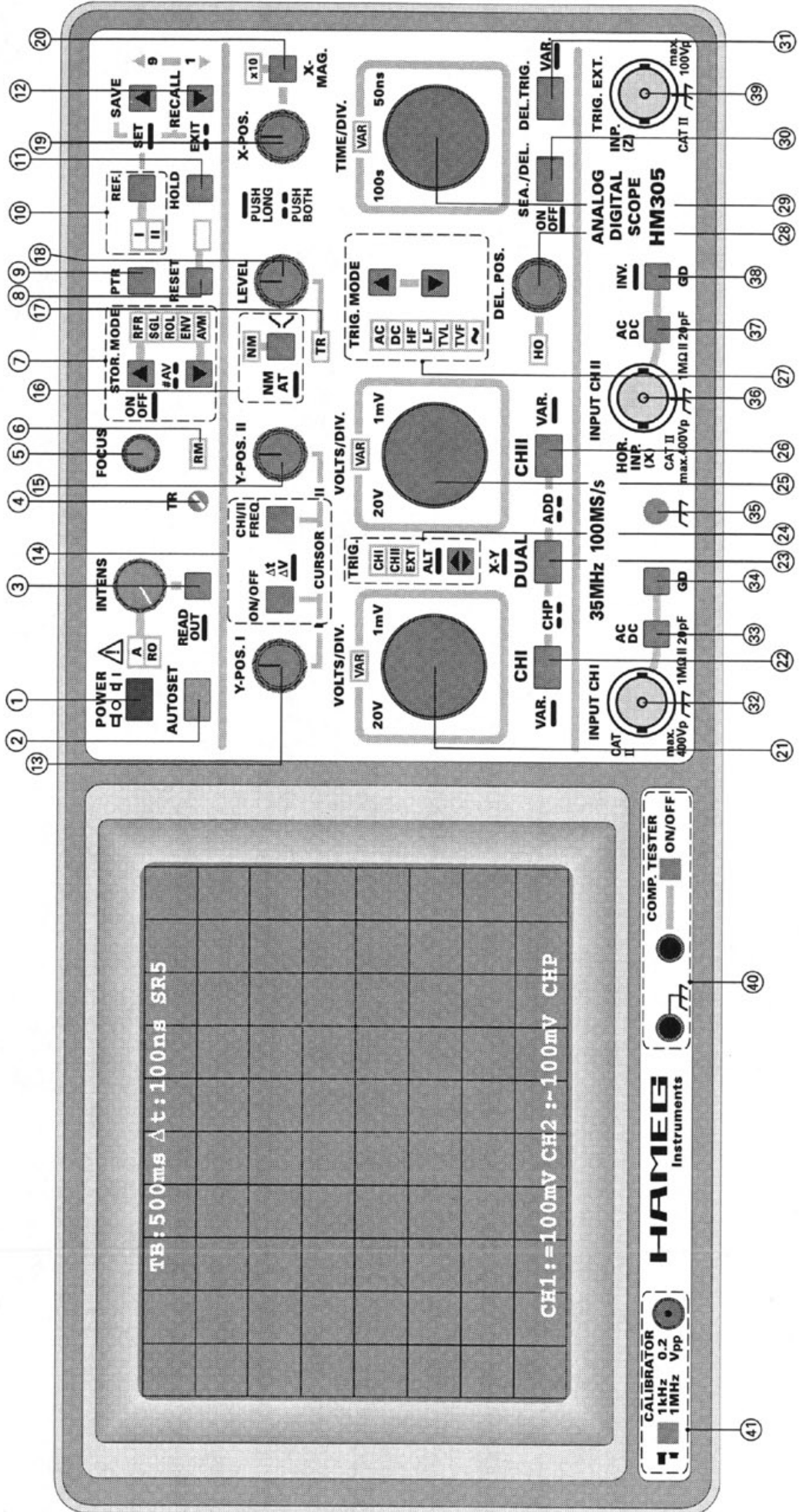

# **HAMEG®**

## **Instruments**

**Oscilloscopes**  
**Multimeters**  
**Counters**  
**Frequency**  
**Synthesizers**  
**Generators**  
**R- and LC-**  
**Meters**  
**Spectrum**  
**Analyzers**  
**Power Supplies**  
**Curve Tracers**  
**Time Standards**

### *Germany*

#### **HAMEG GmbH**

Kelsterbacher Str. 15-19  
60528 FRANKFURT am Main  
Tel. (069) 67805 0  
Telefax (069) 6780513

### *France*

#### **HAMEG S.a.r.l**

5-9, av. de la République  
94800-VILLEJUIF  
Tél. (1) 4677 8151  
Telefax (1) 4726 3544

### *Spain*

#### **HAMEG S.L.**

Villarroel 172-174  
08036 BARCELONA  
Teléf. (9) 3 4301597  
Telefax (9) 3 3212201

### *Great Britain*

#### **HAMEG LTD**

74-78 Collingdon Street  
LUTON Bedfordshire LU1 1RX  
Phone (01582)413174  
Telefax (01582)456416

### *United States of America*

#### **HAMEG, Inc.**

1939 Plaza Real  
OCEANSIDE, CA 92056  
Phone (619) 630 4080  
Telefax (619) 630 6507

#### **HAMEG, Inc.**

266 East Meadow Avenue  
EAST MEADOW, NY 11554  
Phone (516) 794 4080  
Toll-free (800) 247 1241  
Telefax (516) 794 1855

### *Hong Kong*

#### **HAMEG LTD**

Flat 1, 4/F.  
Crown Industrial Building  
106 How Ming St., Kwun Tong  
Kowloon, Hong Kong  
Phone (852) 2 793 0218  
Telefax (852) 2 763 5236